

can-am®



ATV Product Spec Book

2024

Vehicle Specifications, Accessories and Parts

TABLE OF CONTENTS

ATV Accessory Compatibility Guide 5

FEATURED PACKAGES

2024 OutlanderPRO XU 6

2024 OutlanderPRO Hunting Edition 8

2024 Outlander500 2W D 10

2024 OutlanderDPS 500 / 700 12

2024 OutlanderXT 700 14

2024 OutlanderX m r850 16

2024 OutlanderX m r1000R 18

2024 OutlanderXT-P 850 / 1000R 20

2024 OutlanderM AX Limited 1000R 22

2024 OutlanderXT 850 / 1000R 24

2024 Renegade X m r1000R 26

COMPARATIVE CHART 28

G2, G2L, G2S ACCESSORIES 41

G3L ACCESSORIES 81

PARTS AND MAINTENANCE 109

CANAMOFFROAD.COM

* 2023 BombarrierRecreationalProducts Inc. (BRP). All rights reserved. ®/TM and the BRP logo are trademarks of BRP or its affiliates. In the USA, products are distributed by BRP US Inc. All other trademarks are the property of their respective owners. BRP reserves the right to discontinue or change specifications, prices, designs, features, models or equipment without incurring obligation. Some models depicted may include optional equipment. Product performance may vary depending on weather, temperature, altitude, driving ability and driver/passenger weight. BRP recommends that all ATV-SxS drivers take a training course. See your dealer or call the ATV Safety Institute at 1-800-887-2887 (USA) or the Canadian Safety Council at 1-613-739-1535 (Canada). ATVs and SxSs can be hazardous to operate. Never exceed the ATV-SxS's passenger capacity. Always use proper technique to operate. Never operate an ATV or SxS until you have read the operator's manual. Follow all instructions and safety materials and observe applicable laws and regulations. ATVs and SxSs are for off-road use only; never ride on paved surfaces or public roads. For your safety, the operator and passenger(s) must wear a helmet, eye protection and applicable protective clothing. Always remember that riding, alcohol and drugs don't mix. Never engage in stunt driving. Avoid excessive speed and be particularly careful on difficult terrain. Always ride responsibly and safely. See your authorized BRP dealer for details and visit <https://can-am-brp.com>. Printed in Canada.



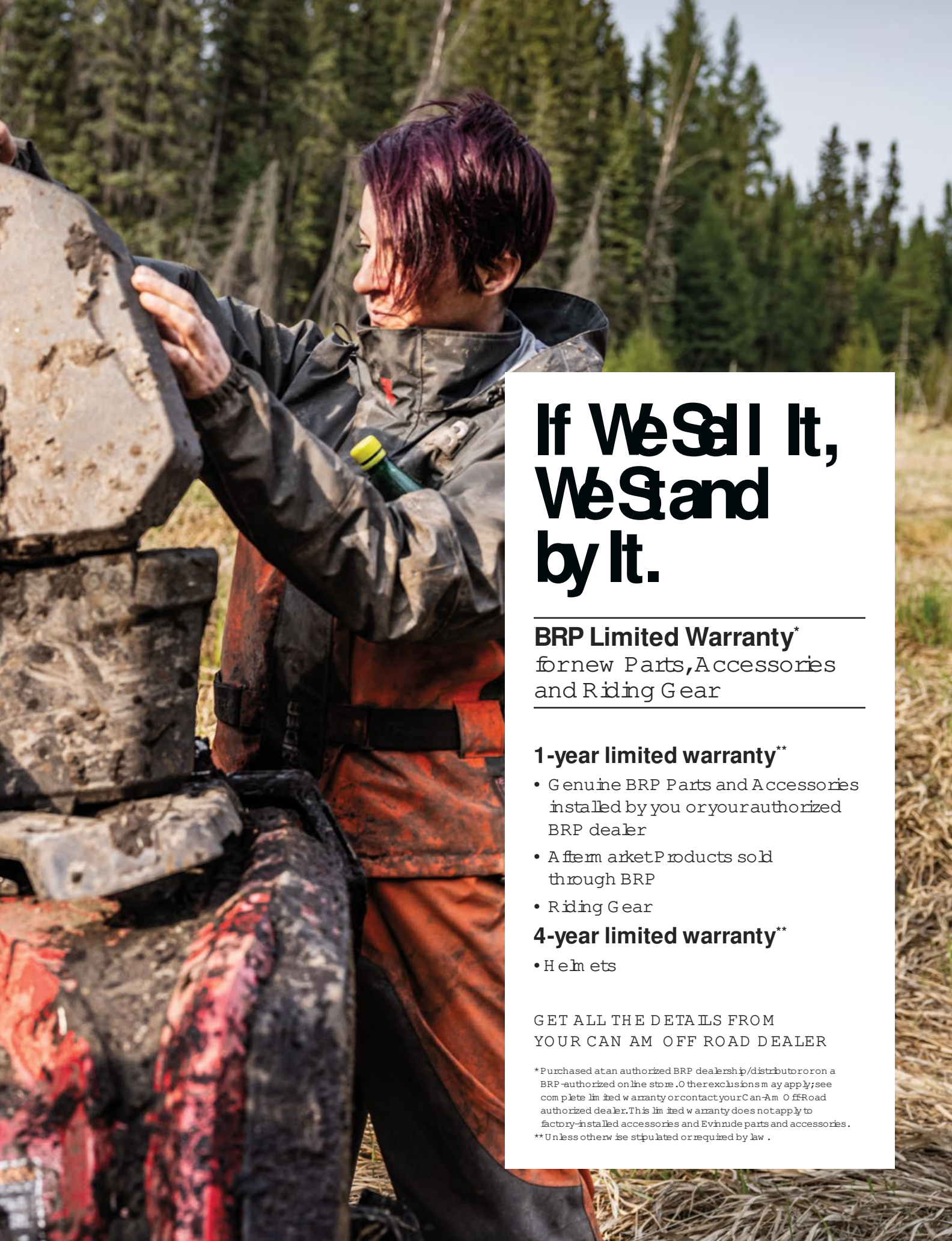

If We Sell It, We Stand by It.

BRP Limited Warranty*

for new Parts, Accessories
and Riding Gear

1-year limited warranty**

- Genuine BRP Parts and Accessories installed by you or your authorized BRP dealer
- Aftermarket Products sold through BRP
- Riding Gear

4-year limited warranty**

- Helmets

GET ALL THE DETAILS FROM
YOUR CAN AM OFF ROAD DEALER

*Purchased at an authorized BRP dealership/distributor or on a BRP-authorized online store. Other exclusions may apply; see complete limited warranty or contact your Can-Am Off Road authorized dealer. This limited warranty does not apply to factory-installed accessories and Evincide parts and accessories.

**Unless otherwise stipulated or required by law.



CUSTOMIZING MADE EASY

1

Select the model.

2

Select the package.

3

Customize color, engine, and accessories (or accessory bundles) for your vehicle.

4

Click Save or Send to dealer.



If you can dream it, you can build it. And ride it. Creating a Can-Am vehicle tailored made for our riders needs has never been easier. Scan the QR code and follow the step-by-step above.

**BUILD
YOUR NOW**

ATV ACCESSORY COMPATIBILITY GUIDE

We've made things super simple.

- Check your model year
- Choose engine and model
- Learn your **PLATFORM CODE**

This **PLATFORM CODE** will let you know at a glance if the accessory is compatible with your vehicle.

Model year	Model	Engine configuration	Platform code
2015	Outlander L	450, 500	G2L
	Outlander	500, 650, 800, 1000	G2
	Outlander L MAX	450, 500	G2L
	Outlander MAX	500, 650, 800, 1000	G2
	6x6	650, 1000	G2
	Renegade	500, 800, 1000	G2S
2016	Outlander L	450, 570	G2L
	Outlander	570, 650, 850, 1000	G2
	Outlander L MAX	450, 570	G2L
	Outlander MAX	570, 650, 850, 1000	G2
	6x6	650, 1000	G2
	Renegade	570, 850, 1000	G2S
2017	Outlander	450, 570	G2L
2018	Outlander	650, 850, 1000	G2
	Outlander MAX	450, 570	G2L
	Outlander MAX	650, 850, 1000	G2
	6x6	650, 1000	G2
	Renegade	570, 850, 1000	G2S
	2019	Outlander	450, 570
2020	Outlander	650, 850, 1000R	G2
2021	Outlander MAX	450, 570	G2L
2022	Outlander MAX	650, 850, 1000R	G2
	6x6	450	G2L
2023	6x6	650, 1000	G2
	Renegade	570, 650, 850, 1000R	G2S
2024	Outlander	500, 700	G3L
	Outlander PRO	HD5, HD7	G3L



2024 OUTLANDER PRO XU



Visco-Lok is a trademark of GKN Visco-Lok GmbH. All other trademarks are the property of their respective owners.
*Base model dry weight shown.



Desert Tan

Feature highlights



Lending a Hand for Steering

The Can-Am Outlander PRO XU comes with high torque Dynamic Power Steering (DPS). The technology counteracts unstable or difficult steering caused by external forces like strong crosswinds or uneven roads. With DPS, you get proper steering assistance from the steering gear to never veer off path.



Rugged XPS Tires and Steel Wheels

The Can-Am Outlander PRO XU sits on 26 in. XPS TrailKing, 6-ply rating tires with 12 in. cast-aluminum wheels built to perform in any condition and in rougher terrains. If you plan to haul, tow, or carry heavy loads with your vehicle, you're in good hands driving on these tires. Because the weather shouldn't stop you from getting work done.



Full Speed Ahead? Almost, But No!

The Can-Am Outlander PRO XU comes with a built-in speed limiter. Where's the fun in that? Well, when it comes time to get work done, you'll see why it comes in handy.



Protection Where It Counts

This model is equipped with a premium front bumper, a central skid plate, and a rear bumper to cover all angles. Think of these as the protective armor of your Can-Am Outlander PRO. No matter the terrain, this ATV is protected from the worst of it and rolls off obstacles.



New and Intelligent Braking

The Intelligent Engine Braking (IEB) of the Can-Am Outlander PRO XU puts the rider in control of the engine braking. When you're carrying heavy loads or riding downhill with full cargo, more engine braking is needed.



Fits Just Like a Glovebox

The Can-Am Outlander PRO XU is equipped with a weather-resistant Premium Glovebox with cellphone holder and USB charger. Rigid and durable, this feature protects your wallet, keys, or whatever else you need from the wild elements. Plus, the magnet on the holder keeps your smartphone in place as it charges up.

2024 OUTLANDER PRO HUNTING EDITION



Visco-Lok is a trademark of GKN ViscoDrive GmbH. All other trademarks are the property of their respective owners.
*Base model dry weight shown.



Wildland Camo

Feature highlights



Lending a Hand for Steering

The Can-Am Outlander PRO Hunting Edition comes with high torque Dynamic Power Steering (DPS). The technology counteracts unstable or difficult steering caused by external forces like strong crosswinds or uneven roads. With DPS, you get proper steering assistance from the steering gear to never veer off path.



Full Speed Ahead? Almost, But No!

The Can-Am Outlander PRO Hunting Edition comes with a built-in speed limiter. Here's the fun in that? Well when it comes time to get work done, you'll see why it comes in handy.



New and Intelligent Braking

The Intelligent Engine Braking (EB) of the Can-Am Outlander PRO Hunting Edition puts the rider in control of the engine braking. When you're carrying heavy loads or riding downhill with full cargo, more engine braking is needed.



Differential that Makes a Difference

The Can-Am Outlander PRO Hunting Edition has a Visco-4 Lok front differential that delivers grip and traction for days whenever you're riding. Engage 4-wheel drive lock mode to deliver equal power to your four wheels, and keep rolling on.



Rugged XPS Tires and Steel Wheels

The Can-Am Outlander PRO Hunting Edition sits on 26 in. XPS TrailKing 6-ply rating tires with 12 in. cast-aluminum wheels built to perform in any condition and in rougher terrains. If you plan to haul, tow, or carry heavy loads with your vehicle, you're in good hands driving on these tires. Because the weather shouldn't get in the way of a ride, it should encourage one.



Made for the Longer Haul

The Can-Am Outlander PRO Hunting Edition comes equipped with a 3,500 lb (1,588 kg) winch. You can engage it with only the flick of a switch to reach the perfect hunting spot. This feature is effective for vehicle recovery, hunting trips, clearing brush, and every tough challenge at the worksite.



Protection Where It Counts

This model is equipped with a premium front bumper, a full skid plate, a rear bumper, and a high molecular weight polyethylene (HMWPE) footwell skid plate, as well as aluminum front and rear fender protectors. Think of these as the protective armor of your Can-Am Outlander PRO Hunting Edition: no matter the terrain or the weather, this ATV is protected from the worst of it.



Fits Just Like a Glovebox

The Can-Am Outlander PRO Hunting Edition is equipped with a weather-resistant Premium Glovebox with cell phone holder and USB charger. Rigid and durable, this feature protects your wallet, keys, or whatever else you need from the wild elements. Plus, the magnet on the holder keeps your smartphone in place as it charges up.

2024 OUTLANDER 500 2WD



Visco-Lok is a trademark of GKN Viscotek GmbH. All other trademarks are the property of their respective owners.
*Base model dry weight shown.



 Legion Red

Feature highlights



It Takes Two to Ride

On the Can-Am Outlander, two wheels propel you forward, while all four of them rotate. Those two wheels receive power and torque from your engine to make your riding smooth and efficient.



Stands Out and Stands Tall

Who says size doesn't matter? At 12 inches high, the Can-Am Outlander looks down on anything in its way. That amount of ground clearance means it can easily absorb shocks and avoid damage to the chassis and underbody from scraping. Go ahead and tame the wild terrains you drive across.



Durable, Strong and Reliable

The full skid plate on the Can-Am Outlander protects the underbelly of your ride as you chase thrills. Smoothen the roughest types of terrain and glide over the biggest obstacles.

2024 OUTLANDER DPS 500 / 700



Visco-Lok is a trademark of GKN Viscotek GmbH. All other trademarks are the property of their respective owners.
*Base model dry weight shown.



■ Granite Gray

Feature highlights



Lending a Hand for Steering

The Can-Am Outlander DPS 500/700 comes with high torque Dynamic Power Steering (DPS). The technology counteracts unstable or difficult steering caused by external forces like strong crosswinds or uneven roads. With DPS, you get proper steering assistance from the steering gear to never veer off path.



Differential That Makes a Difference

The Can-Am Outlander DPS 500/700 has a Visco-Lok Q.E. (Quick Engagement) auto-locking front differential that delivers grip for days. The advantage of this feature is that engaging the front differential is quicker: with no rev or speed limiter, optimal wheel traction follows you on every ride.



Durable, Strong and Reliable

The full skid plate on the Can-Am Outlander DPS 500/700 protects the underbelly of your ride as you chase thrills. Smoothen the roughest types of terrain and glide over the biggest obstacles.

2024 OUTLANDER XT 700



Visco-Lok is a trademark of GKN Viscotrive GmbH. All other trademarks are the property of their respective owners.
*Base model dry weight shown.



Neo Yellow

Feature highlights



Lending a Hand for Steering

The Can-Am Outlander XT 700 comes with high torque Dynamic Power Steering (DPS). The technology counteracts unstable or difficult steering caused by external forces like strong crosswinds or uneven roads. With DPS, you get proper steering assistance from the steering gear to never veer off path.



Versatility in a Pinch

With a Can-Am HD 3500 Winch on, your ATV is full of versatility. Engage it with the flick of a switch to get the most difficult tasks done and keep things rolling on your Can-Am Outlander XT 700. Whether you need to clear the way, rescue a friend or pull out of a tough spot, this winch helps you make it happen: it's effective for vehicle recovery, hunting trips, clearing brush, and at the job site.



Differential That Makes a Difference

The Can-Am Outlander XT 700 has a Visco-Lok QE Quick Engagement auto-locking front differential that delivers grip for days. The advantage of this feature is that engaging the front differential is quicker with no rev or speed limiter, optimal wheel traction follows you on every ride.



Protection Where It Counts

This model is equipped with a full ski plate as well as front and rear bumpers. Think of these as your Can-Am Outlander XT 700's protective armor: no matter the terrain, this ATV is protected from the worst of it.



Rugged XPS Tires and Steel Wheels

The Can-Am Outlander XT 700 sits on 26 in. XPS Trail Force tires with 14 in. aluminum wheels built to perform in any condition. Because the weather shouldn't get in the way of a ride, it should encourage one.



Fits Just Like a Glovebox

The Can-Am Outlander XT 700 is equipped with a weather-resistant Premium Glovebox with cellphone holder and USB charger. Rigid and durable, this feature protects your wallet, keys, or whatever else you need from the weather elements. Plus, the magnet on the holder keeps your smartphone in place as it charges up.

2024 OUTLANDER X MR 850



Visco-Lok is a trademark of GKN Viscodrive GmbH. All other trademarks are the property of their respective owners.
*Base model dry weight shown.



 Legion Red

Feature highlights



Ever Been Snorkeling?

The snorkel'd CVT and engine intake and exhaust on the Can-Am Outlander X mr850 is every mud rider's dream. On this ATV, the air intake is strategically positioned to provide your engine with cooler intake air temperatures for additional performance when you hit the swamp.



Feel It in the Air

The Can-Am Outlander X mr850 makes things easier for you when you ride with a relocated radiator, the airflow will be better on your ATV. Plus, the new location makes it easier to clean and maintain the radiator. That's what you call in-wind.



Lending a Hand for Steering

The Can-Am Outlander X mr850 comes with Trim Mode Dynamic Power Steering (DPS). With progressive trim modes (in, med, max), the technology counteracts unstable or difficult steering caused by external forces like strong crosswinds or uneven roads. With DPS, you get proper steering assistance from the steering gear to never veer off path.



Differential that Makes a Difference

The Can-Am Outlander X mr850 has a Visco-4 Lok front differential that delivers grip and traction for days wherever you're riding. Engage 4-wheel drive lock mode to deliver equal power to your four wheels, and keep rolling on.



Versatile Tires and Aluminum Wheels

The Can-Am Outlander X mr850 sits on 30 in. TP-Cryptid tires with 14 in. aluminum wheels. It's designed and built for those who love the mud, those who love the trail, and those who love both! Because the weather shouldn't get in the way of a good ride, it should encourage one.

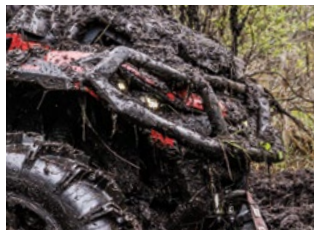

Protection Where It Counts

This model is equipped with heavy-duty front and rear bumpers. Think of these as your ATV's protective armor. No matter the terrain, this ATV is protected from the worst of it. Clear the way confidently with enhanced protection from obstacles you drive across.



Made for the Muddier Ride

The Can-Am Outlander X mr850 comes equipped with a 3,500-lb (1,588 kg) winch. You can engage it with only the flick of a switch to dominate the most challenging terrain. This feature is effective for vehicle recovery, hunting trips, clearing brush, and pushing further on every mud adventure.



The Perfect Place to Rest

Dependable mud-riding footrests are a godsend on this model. With an innovative design that keeps riders in their seat regardless of how messy the adventure gets, these footrests deliver a more thrilling and comfortable mud ride. Stay firmly saddled on this ATV at all times and in all conditions.

2024 OUTLANDER XMR 1000R



Visco-Lok is a trademark of GKN Viscotrivve GmbH. All other trademarks are the property of their respective owners.
*Base model dry weight shown.



 HyperSilver & Legion Red

Feature highlights



Ever Been Snorkeling?

The Rotax® smoke-leaded CVT and engine intake and exhaust on the Can-Am Outlander X mr 1000R is every mud rider's dream. On this ATV, the air intake provides your engine with cooler intake air temperatures for additional performance when you hit the swamp. And with a capacity of up to 91 hp, it's ready to go full throttle!



Feel It in the Air

The Can-Am Outlander X mr 1000R makes things easier for you when you ride with a relocated radiator; the airflow will be better over your ATV. Plus, the new location makes it easier to clean and maintain the radiator. That's what you call win-win.



Lending a Hand for Steering

The Can-Am Outlander X mr 1000R comes with Trim Mode Dynamic Power Steering (DPS). With progressive trim modes (in, med, max), the technology counteracts unstable or difficult steering caused by external forces like strong crosswinds or uneven roads. With DPS, you get power steering assistance from the steering gear to never veer off path.



Differential that Makes a Difference

The Can-Am Outlander X mr 1000R has a Visco-4 Lok front differential that delivers grip and traction for days whenever you're riding. Engage 4-wheel drive lock mode to deliver equal power to your four wheels, and keep rolling on.



Versatile Tires and Aluminum Wheels

The Can-Am Outlander X mr 1000R sits on 30 in. TP-Cryptid tires with 14 in. aluminum wheels. It's designed and built for those who love the mud, those who love the trail, and those who love both!



Protection Where It Counts

This model is equipped with heavy-duty front and rear bumpers. Think of these as your ATV's protective armor: no matter the terrain, this ATV is protected from the worst of it. Clear the way confidently with enhanced protection from obstacles you drive across.



Made for the Muddier Ride

The Can-Am Outlander X mr 1000R comes equipped with a 3,500-lb (1,588 kg) winch. You can engage it with only the flick of a switch to dominate the most challenging terrain. This feature is effective for vehicle recovery, hunting trips, clearing brush, and pushing further on every mud adventure.



The Perfect Place to Rest

Dependable mud-riding footrests are a godsend on this model. With an innovative design that keeps riders in their seat regardless of how messy the adventure gets, these footrests deliver a more thrilling and comfortable mud ride. Stay firmly saddled on this ATV at all times and in all conditions.

2024 OUTLANDER XFP 850 / 1000R



Visco-Lok is a trademark of GKN Viscotek GmbH. All other trademarks are the property of their respective owners.
*Base model dry weight shown.



HyperSilver & Neo Yellow

Feature highlights



Lending a Hand for Steering

The Can-Am Outlander XT-P comes with Trim Mode Dynamic Power Steering (DPS). With progressive trim modes (in, med, m ax), the technology counteracts unstable or difficult steering caused by external forces like strong crosswinds or uneven roads. With DPS, you get proper steering assistance from the steering gear to never veer off path.



Protection Where It Counts

This model is equipped with heavy-duty front and rear bumpers. Think of these as your ATV's protective armor: no matter the terrain, this ATV is protected from the worst of it. Clear the way confidently with enhanced protection from obstacles you drive across.



Differential that Makes a Difference

The Can-Am Outlander XT-P has a Visco-Lok front differential that delivers grip and traction for days whenever you're riding. Engage 4-wheel-drive lock mode to deliver equal power to your four wheels, and keep rolling on.



Versatility in a Pinch

With a Can-Am HD 3500 Winch on, your ATV is full of versatility. Engage it with the flick of a switch to get the most difficult tasks done and keep things rolling on your Can-Am Outlander XT-P. Whether you need to clear the way, rescue a friend or pull out of a tough spot, this winch helps you make it happen.

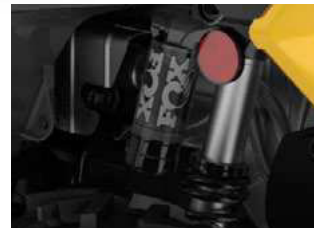

Adapt to Changing Conditions

Ready for more? The FOX 1.5 PODIUM QS3 shocks are high-performance front and rear shocks that modulate handling of the Outlander XT-P to adapt to any terrain and riding style. Switch from soft to firm depending where you're going, then head out for more fun.



Wrapping Your Hands Up

The Outlander XT-P handlebar was designed to elevate your comfort. With an aluminum-taper profile and full wrap handguards, you've got additional comfort and protection from the elements within your grasp.



Versatile Tires and Aluminum Wheels

The Can-Am Outlander XT-P sits on 26 in. TTP Tencross radials. With an interlocking tread pattern and a wide footprint, the result is exceptional traction. The versatile Tencross is designed to overcome a wide variety of challenging conditions.

2024 OUTLANDER MAX LIMITED 1000R



Visco-Lok is a trademark of GKN Viscodrive GmbH. All other trademarks are the property of their respective owners.
*Base model dry weight shown.



Stone Gray

Feature highlights



Lending a Hand for Steering

The Can-Am Outlander MAX Limited 1000R comes with Trim Mode Dynamic Power Steering (DPS). With progressive trim modes (min, med, max), the technology counteracts unstable or difficult steering caused by external forces like strong crosswinds or uneven roads. With DPS, you get proper steering assistance from the steering gear to never veer off path.



Protection Where It Counts

This model is equipped with heavy-duty front and rear bumpers. Think of these as your ATV's protective armor: no matter the terrain, this ATV is protected from the worst of it. Clear the way confidently with enhanced protection from obstacles you drive across.



Differential that Makes a Difference

The Can-Am Outlander MAX Limited 1000R has a Visco-4 Lok front differential that delivers grip and traction for days whenever you're riding. Engage 4-wheel drive lock mode to deliver equal power to your four wheels, and keep rolling on.



Versatility in a Pinch

With a Can-Am HD 3500 Winch on, your ATV is full of versatility. Engage it with the flick of a switch to get the most difficult tasks done and keep things rolling on your Can-Am Outlander MAX Limited 1000R. Whether you need to clear the way, rescue a friend or pull out of a tough spot, this winch helps you make it happen: it's effective for vehicle recovery, hunting trips, clearing brush, and at the job site.



Adapt to Changing Conditions

Ready for more? The FOX 1.5 PODIUM Q53 shocks are high-performance front and rear shocks that modulate handling of the Outlander MAX Limited 1000R to adapt to any terrain and riding style. Switch from soft to firm depending where you're going, then head out for more fun.



Wrapping Your Hands Up

The Can-Am Outlander MAX Limited 1000R handlebar was designed to elevate your comfort. With an aluminum-taper profile and full wrap handguards, you've got additional comfort and protection from the elements within your grasp.



Versatile Tires and Aluminum Wheels

The Can-Am Outlander MAX Limited 1000R sits on 27-inch axxis Bighorn 2.0 tires with 14-inch aluminum wheels. Based on the legendary Bighorn, its tread design recalls the original with slimmer sipes. It's the lightest and most versatile racing tire, but that doesn't make it a lightweight!



Essential Info at Your Fingertips

The 7.6-inch digital display keeps crucial information at hand in your Can-Am Outlander MAX Limited 1000R. Features include speedometer, gear position, temperature, engine lights control, electronic fuel gauge, clock, and more.

2024 OUTLANDER XT 850 / 1000R



Visco-Lok is a trademark of GKN Viscodrive GmbH. All other trademarks are the property of their respective owners.
*Base model dry weight shown.



 **Fiery Red**

Feature highlights



Lending a Hand for Steering

The Can-Am Outlander XT 850 comes with Tri-Mode Dynamic Power Steering (DPS). With progressive trim modes (in, med, max), the technology counteracts unstable or difficult steering caused by external forces like strong crosswinds or uneven roads. With DPS, you get proper steering assistance from the steering gear to never veer off path.



Differential That Makes a Difference

The Can-Am Outlander XT 850 has a Visco-Lok Q.E. Quick Engagement auto-locking front differential that delivers grip for days. The advantage of this feature is that engaging the front differential is now even quicker, with no rev or speed limiter, optimal wheel traction follows you on every rille.



Versatile Tires and Aluminum Wheels

The Can-Am Outlander XT 850 sits on 26 in. ITP Terracross radial tires. With an interlocking tread pattern and a wide footprint, the result is exceptional traction. The versatile Terracross is designed to overcome a wide variety of challenging conditions.



Protection Where It Counts

This model is equipped with heavy-duty front and rear bumpers to cover all angles. Think of these as the protective armor of your Can-Am Outlander XT 850: no matter the terrain, this ATV is protected from the worst of it and rolls off obstacles.



Made for the Longer Haul

The Can-Am Outlander XT 850 comes equipped with a 3,500-lb (1,588 kg) winch. You can engage it with only the flick of a switch to dominate the most difficult tasks. This feature is effective for vehicle recovery, hunting trips, clearing brush, and every tough challenge at the worksite.



Deflect Wind, Not Fun

Whenever you set out on a ride aboard your trusted ATV, you want to be comfortable, and you want to be safe. You can easily improve both thanks to our stylish line of ATV handlebars that keep the wind and other elements at bay.

2024 RENEGADE XMR 1000R



Visco-Lok is a trademark of GKN ViscoDrive GmbH. All other trademarks are the property of their respective owners.
*Base model dry weight shown.



 HyperSilver & Legion Red

Feature highlights



Ever Been Snorkeling?

The Rotax® snorkeled CVT and engine intake and exhaust on the Can-Am Renegade X mr1000R is every mud rider's dream. On this ATV, the air intake provides your engine with cooler intake air temperatures for additional performance when you hit the swamp. And with a capacity of up to 91 hp, it's ready to go full throttle!



Lending a Hand for Steering

The Can-Am Renegade X mr1000R comes with Trim Mode Dynamic Power Steering (DPS). With progressive trim modes (in, med, max), the technology counteracts unstable or difficult steering caused by external forces like strong crosswinds or uneven roads. With DPS, you get proper steering assistance from the steering gear to never veer off path.



Differential that Makes a Difference

The Can-Am Renegade X mr1000R has a Visco-4 Lok front differential that delivers grip and traction for days whenever you're riding. Engage 4-wheel-drive lock mode to deliver equal power to your four wheels, and keep rolling on.



Versatile Tires and Aluminum Wheels

The Can-Am Renegade X mr1000R sits on 30 in. ITP Cryptid tires with 14 in. aluminum wheels. It's designed and built for those who love the mud, those who love the trail, and those who love both!



Versatility in a Pinch

With a Can-Am HD 3500 Winch on, your ATV is full of versatility. Engage it with the flick of a switch to get the most difficult tasks done and keep things rolling on your Can-Am Renegade X mr1000R. Whether you need to clear the way, rescue a friend or pull out of a tough spot, this winch helps you make it happen: it's effective for vehicle recovery, hunting trips, clearing brush, and at the job site.



Front & Central Skid Plate

The front and central skid plate made of aluminum that sits under the Can-Am Renegade X mr1000R allows you to glide smoothly over obstacles. The end result is great protection in rough terrain.





Protection Where It Counts

This model is equipped with heavy-duty front and rear bumpers. Think of these as your ATV's protective armor. No matter the terrain, this ATV is protected from the worst of it. Clear the way confidently with enhanced protection from obstacles you drive across.





Guarding Your Hands



This vehicle has an aluminum taper-profile handlebar with full-wrap handguards for additional comfort and protection against the outside elements. It fits the profile of the aggressive rider who likes to push further, because it doesn't compromise on safety or comfort.

		OUTLANDER PRO	
			
COLOR OPTIONS		Desert Tan Tundra Green	
ENGINES	Type	HD 5 40 hp / 37 b-ft, Rotax [®] ACE (Advanced Combustion Efficiency) 650 cc, single-cylinder, liquid-cooled	HD 7 50 hp / 41 b-ft, Rotax [®] ACE (Advanced Combustion Efficiency) 650 cc, single-cylinder, liquid-cooled
	Fuel Delivery System	Electronic Fuel Injection (EFI)	
	Transmission	5-speed primary CVT with work calibration Extra low L / H / N / R / P	
	Drive Train	Selectable 2WD / 4WD with Visco-Lok auto-locking front differential	
	Driving Assistance	N/A	
	Power Steering	N/A	
SUSPENSIONS	Front Suspension	Double A-arm 9.75 in. (24.8 cm) travel	
	Front Shocks	Tw in-tube	
	Rear Suspension	Double A-arm 10.25 in. (26 cm) travel	
	Rear Shocks	Tw in-tube	
TIRES / WHEELS	Tires	6-ply rating 26 x 8 / 10 x 12 in.	
	Wheels	12 in. steel	
BRAKES	Front	Dual 214 mm disc brakes with hydraulic twin-piston calipers	
	Rear	Single 214 mm disc brake with hydraulic twin-piston caliper	
DIMENSIONS / CAPACITIES	Estimated Dry Weight*	800 lb (362.9 kg)	
	L x W x H	89.9 x 48.8 x 48.2 in. (228.4 x 123.9 x 122.5 cm)	
	Wheelbase	53 in. (134.5 cm)	
	Ground Clearance	13 in. (33 cm)	
	Seat Height	38.6 in. (98 cm)	
	Rack Capacity	Front: 120 lb (54.4 kg) / Rear: 240 lb (109 kg)	
	Storage Capacity	9 gal (34 L)	
	Towing Capacity	1,830 lb (830 kg)	
	Fuel Capacity	5.1 gal (19.5 L)	
FEATURES	Gauge	4.5 in. digital display	
	Instrumentation	N/A	
	Ignition	Mechanical key	
	Lighting	LED headlights and taillights	
	Winch	N/A	
	Seat	Standard	
	Handlebar	Standard	
	Protection	Front fender front bumper Rear bumper Full skid plate	
	Warranty	6-month BRP limited warranty	

Visco-Lok is a trademark of GKN Visco Drive GmbH. All other trademarks are the property of their respective owners.
 *Base model dry weight shown.

		OUTLANDER PRO XU		OUTLANDER PRO Hunting Edition	
					
COLOR OPTIONS		Desert Tan Tundra Green		Wildland Camo	
ENGINES	Type	HD5 40 hp / 37 b-ft, Rotax® ACE (Advanced Combustion Efficiency) 650 cc, single cylinder, liquid-cooled	HD7 50 hp / 41 b-ft, Rotax® ACE (Advanced Combustion Efficiency) 650 cc, single cylinder, liquid-cooled	HD5 40 hp / 37 b-ft, Rotax® ACE (Advanced Combustion Efficiency) 650 cc, single cylinder, liquid-cooled	HD7 50 hp / 41 b-ft, Rotax® ACE (Advanced Combustion Efficiency) 650 cc, single cylinder, liquid-cooled
	Fuel Delivery System	Intelligent Throttle Control (ITC) with Electronic Fuel Injection (EFI)		Intelligent Throttle Control (ITC) with Electronic Fuel Injection (EFI)	
	Transmission	pDrive primary CVT with work calibration Extra low L / H / N / R / P		pDrive primary CVT with work calibration Extra low L / H / N / R / P	
	Drive Train	Selectable 2WD / 4WD / Lock 4WD with Visco-4 Lok front differential		Selectable 2WD / 4WD / Lock 4WD with Visco-4 Lok front differential	
	Driving Assistance	Intelligent Engine Braking (IEB) Speed limiter	Work / Standard / Sport modes Intelligent Engine Braking (IEB) Speed limiter	Intelligent Engine Braking (IEB) Speed limiter	Work / Standard / Sport modes Intelligent Engine Braking (IEB) Speed limiter
	Power Steering	Trimode Dynamic Power Steering (DPS)		Trimode Dynamic Power Steering (DPS)	
	SUSPENSIONS	Front Suspension	Double A-arm 9.75 in. (248 cm) travel		Double A-arm 9.75 in. (248 cm) travel
Front Shocks		Tw in-tube		Tw in-tube	
Rear Suspension		Double A-arm 10.25 in. (26 cm) travel		Double A-arm 10.25 in. (26 cm) travel	
Rear Shocks		Tw in-tube		Tw in-tube	
TIRES / WHEELS	XPS TrailKing, 6-ply rating, 26 x 8 / 10 x 12 in. 12 in. cast aluminum		XPS TrailKing, 6-ply rating, 26 x 8 / 10 x 12 in. 12 in. cast aluminum		
BRAKES	Front	Dual 214 mm disc brakes with hydraulic twin-piston calipers		Dual 214 mm disc brakes with hydraulic twin-piston calipers	
	Rear	Single 214 mm disc brake with hydraulic twin-piston caliper		Single 214 mm disc brake with hydraulic twin-piston caliper	
DIMENSIONS / CAPACITIES	Estimated Dry Weight*	816 lb (370.1 kg)		828 lb (375.6 kg)	
	L x W x H	89.9 x 48.8 x 48.2 in. (228.4 x 123.9 x 122.5 cm)		89.9 x 48.8 x 48.2 in. (228.4 x 123.9 x 122.5 cm)	
	Wheelbase	53 in. (134.5 cm)		53 in. (134.5 cm)	
	Ground Clearance	13 in. (33 cm)		13 in. (33 cm)	
	Seat Height	38.6 in. (98 cm)		38.6 in. (98 cm)	
	Rack Capacity	Front: 120 lb (54.4 kg) / Rear: 240 lb (109 kg)		Front: 120 lb (54.4 kg) / Rear: 240 lb (109 kg)	
	Storage Capacity	9 gal (34 L)		9 gal (34 L)	
	Towing Capacity	1,830 lb (830 kg)		1,830 lb (830 kg)	
	Fuel Capacity	5.1 gal (19.5 L)		5.1 gal (19.5 L)	
FEATURES	Gauge	4.5 in. digital display		4.5 in. digital display	
	Instrumentation	USB phone charger		USB phone charger	
	Ignition	RF Digital Encoded Security System (DESS)		RF Digital Encoded Security System (DESS)	
	Lighting	LED headlights and taillights		LED headlights and taillights	
	Winch	N/A		3,500 lb (1,588 kg) winch	
	Seat	Standard		Standard	
	Handlebar	Standard		Standard	
	Protection	Pneum front bumper Rear bumper Full ski plate		Pneum front bumper Rear bumper Full ski plate HMWPE snow skid plate Aluminum front and rear fender protectors	
	Warranty	6-month BRP limited warranty		6-month BRP limited warranty	



Visco-Lok is a trademark of GKN Visco Drive GmbH. All other trademarks are the property of their respective owners.
*Base model dry weight shown.

		OUTLANDER 500 2WD	OUTLANDER 500 700	
				
COLOR OPTIONS		Legion Red	Granite Gray Legion Red	Granite Gray Legion Red
ENGINES	Type	500 40 hp / 37 b-ft, Rotax® ACE (Advanced Combustion Efficiency) 650 cc, single-cylinder, liquid-cooled	500 40 hp / 37 b-ft, Rotax® ACE (Advanced Combustion Efficiency) 650 cc, single-cylinder, liquid-cooled	700 50 hp / 41 b-ft, Rotax® ACE (Advanced Combustion Efficiency) 650 cc, single-cylinder, liquid-cooled
	Fuel Delivery System	Electronic Fuel Injection (EFI)		
	Transmission	5-Speed Premium CVT L / H / N / R / P		
	Drive Train	2WD system		
	Driving Assistance	N/A		
	Power Steering	N/A		
	SUSPENSIONS	Front Suspension	Double A-arm 9.75 in. (24.8 cm) travel	
Front Shocks		Tw in-tube		
Rear Suspension		Double A-arm 10.25 in. (26 cm) travel		
Rear Shocks		Tw in-tube		
TIRES / WHEELS	Tires	25 x 8 / 10 x 12 in.		
	Wheels	12 in. steel		
BRAKES	Front	Dual 214 mm disc brakes with hydraulic twin-piston calipers		
	Rear	Single 214 mm disc brake with hydraulic twin-piston caliper		
DIMENSIONS / CAPACITIES	Estimated Dry Weight*	718 lb (325.7 kg)	740 lb (335.7 kg)	
	L x W x H	86.7 x 47.6 x 48 in. (220.2 x 120.9 x 122 cm)		
	Wheelbase	53 in. (134.5 cm)		
	Ground Clearance	12 in. (30.5 cm)		
	Seat Height	38 in. (96.7 cm)		
	Rack Capacity	Front: 120 lb (54.4 kg) / Rear: 240 lb (109 kg)		
	Storage Capacity	9 gal (34 L)		
	Towing Capacity	1,830 lb (830 kg)		
	Fuel Capacity	5.1 gal (19.5 L)		
FEATURES	Gauge	4.5 in. digital display		
	Instrumentation	N/A		
	Ignition	Mechanical key		
	Lighting	LED headlights and taillights		
	Winch	N/A		
	Seat	Standard		
	Handlebar	Standard		
	Protection	Fullskid plate		
	Warranty	6-month BRP limited warranty		

Visco-Lok is a trademark of GKN Visco Drive GmbH. All other trademarks are the property of their respective owners.
*Base model dry weight shown.

		OUTLANDER DPS 500 / 700		OUTLANDER XT 700	OUTLANDER X mr 700
					
COLOR OPTIONS		Granite Gray Legion Red Wildland Camo		Platinum Satin Neo Yellow	Legion Red
ENGINES	Type	500 40 hp / 37 b-ft, Rotax® ACE (Advanced Combustion Efficiency) 650 cc, single-cylinder, liquid-cooled	700 50 hp / 41 b-ft, Rotax® ACE (Advanced Combustion Efficiency) 650 cc, single-cylinder, liquid-cooled	700 50 hp / 41 b-ft, Rotax® ACE (Advanced Combustion Efficiency) 650 cc, single-cylinder, liquid-cooled	700 50 hp / 41 b-ft, Rotax® ACE (Advanced Combustion Efficiency) 650 cc, single-cylinder, liquid-cooled with strategically positioned engine air intake
	Fuel Delivery System	Electronic Fuel Injection (EFI)		Electronic Fuel Injection (EFI)	Intelligent Throttle Control (ITC) with Electronic Fuel Injection (EFI)
	Transmission	pDrive™ primary CVT L/H/N/R/P		pDrive™ primary CVT L/H/N/R/P	pDrive™ primary CVT with strategically positioned air intake and exhaust Extra Low L/H/N/R/P
	Drive Train	Selectable 2WD / 4WD with Visco-Lok™ QE auto-locking front differential		Selectable 2WD / 4WD with Visco-Lok™ QE auto-locking front differential	Selectable 2WD / 4WD / Lock 4WD with Visco-Lok™ front differential
	Driving Assistance	N/A		N/A	Work / Standard / Sport modes
	Power Steering	Trimode Dynamic Power Steering (DPS)		Trimode Dynamic Power Steering (DPS)	Trimode Dynamic Power Steering (DPS)
	SUSPENSIONS	Front Suspension	Double A-arm 9.75 in. (24.8 cm) travel		Double A-arm 9.75 in. (24.8 cm) travel
Front Shocks	Tw in-tube		Tw in-tube	Tw in-tube	
Rear Suspension	Double A-arm 10.25 in. (26 cm) travel		Double A-arm 10.25 in. (26 cm) travel	Double A-arm 9.75 in. (24.8 cm) travel	
Rear Shocks	Tw in-tube		Tw in-tube	Tw in-tube	
TIRES / WHEELS	Tires	25 x 8 / 10 x 12 in. 12 in. steel		XPS TrailForce 26 x 8 / 10 x 14 in. 14 in. aluminum	XPS Swamp King 28 x 8 / 10 x 14 in. 14 in. aluminum
BRAKES	Front	Dual 214 mm disc brakes with hydraulic twin-piston calipers		Dual 214 mm disc brakes with hydraulic twin-piston calipers	Dual 214 mm disc brakes with hydraulic twin-piston calipers
	Rear	Single 214 mm disc brake with hydraulic twin-piston caliper		Single 214 mm disc brake with hydraulic twin-piston caliper	Single 214 mm disc brake with hydraulic twin-piston caliper
DIMENSIONS / CAPACITIES	Estimated Dry Weight*	750 lb (342 kg)		858 lb (392 kg)	876 lb (397 kg)
	L x W x H	86.7 x 47.6 x 48 in. (220.2 x 120.9 x 122 cm)		89.9 x 48.8 x 48.2 in. (228.4 x 123.9 x 122.5 cm)	89.9 x 48.8 x 48.2 in. (228.4 x 123.9 x 122.5 cm)
	Wheelbase	53 in. (134.5 cm)		53 in. (134.5 cm)	53 in. (134.5 cm)
	Ground Clearance	12 in. (30.5 cm)		12.5 in. (31.8 cm)	13 in. (33 cm)
	Seat Height	38 in. (96.7 cm)		38.5 in. (98 cm)	38.5 in. (98 cm)
	Rack Capacity	Front: 120 lb (54 kg) / Rear: 240 lb (109 kg)		Front: 120 lb (54 kg) / Rear: 240 lb (109 kg)	Front: 120 lb (54 kg) / Rear: 240 lb (109 kg)
	Storage Capacity	9 gal (34 L)		9 gal (34 L)	9 gal (34 L)
	Towing Capacity	1,830 lb (830 kg)		1,830 lb (830 kg)	1,830 lb (830 kg)
	Fuel Capacity	5.1 gal (19.5 L)		5.1 gal (19.5 L)	5.1 gal (19.5 L)
FEATURES	Gauge	4.5 in. digital display		4.5 in. digital display	4.5 in. digital display
	Instrumentation	N/A		USB phone charger	USB phone charger
	Ignition	Mechanical key		Mechanical key	RFID digitally Encoded Security System (DESS) with cord
	Lighting	LED headlights and taillights		LED headlights and taillights	LED headlights and taillights
	Winch	N/A		3,500 lb (1,588 kg) winch	N/A
	Seat	Standard		Standard	Standard
	Handlebar	Standard		Standard	Standard
	Protection	Fullskid plate		Front and rearbumper per Fullskid plate	Frontbumper per Xmr footpegs, fullskid plate
	Warranty	6-month BRP limited warranty		6-month BRP limited warranty	6-month BRP limited warranty



Visco-Lok is a trademark of GKN Visco Drive GmbH. All other trademarks are the property of their respective owners.
*Base model only, weight shown.

		OUTLANDER MAX DPS 500 700		OUTLANDER MAX XT 700
				
COLOR OPTIONS		Granite Gray Lemon Red	Granite Gray Lemon Red	Patinum Satin Neo Yellow
ENGINES	Type	500 40 hp / 37 b-ft, Rotax [®] ACE (Advanced Combustion Efficiency) 650 cc, single-cylinder, liquid-cooled	700 50 hp / 41 b-ft, Rotax [®] ACE (Advanced Combustion Efficiency) 650 cc, single-cylinder, liquid-cooled	700 50 hp / 41 b-ft, Rotax [®] ACE (Advanced Combustion Efficiency) 650 cc, single-cylinder, liquid-cooled
	Fuel Delivery System	Electronic Fuel Injection (EFI)		Electronic Fuel Injection (EFI)
	Transmission	p Drive primary CVT L / H / N / R / P		p Drive primary CVT L / H / N / R / P
	Drive Train	Selectable 2WD / 4WD with Visco-Lok Q.E. auto-locking front differential		Selectable 2WD / 4WD with Visco-Lok Q.E. auto-locking front differential
	Driving Assistance	N/A		N/A
	Power Steering	Trim Mode Dynamic Power Steering (DPS)		Trim Mode Dynamic Power Steering (DPS)
SUSPENSIONS	Front Suspension	Double A-arm 9.75 in. (24.8 cm) travel		Double A-arm 9.75 in. (24.8 cm) travel
	Front Shocks	Tw in-tube		Tw in-tube
	Rear Suspension	Double A-arm 10.25 in. (26 cm) travel		Double A-arm 10.25 in. (26 cm) travel
	Rear Shocks	Tw in-tube		Tw in-tube
TIRES / WHEELS	Tires	25 x 8 / 10 x 12 in. 12 in. steel		XPS TrailForce 26 x 8 / 10 x 14 in. 14 in. aluminum
	Wheels			
BRAKES	Front	Dual 214 mm disc brakes with hydraulic twin-piston calipers		Dual 214 mm disc brakes with hydraulic twin-piston calipers
	Rear	Single 214 mm disc brake with hydraulic twin-piston caliper		Single 214 mm disc brake with hydraulic twin-piston caliper
DIMENSIONS / CAPACITIES	Estimated Dry Weight*	785 lb (356.1 kg)		893 lb (405.1 kg)
	L x W x H	94.2 x 47.6 x 54 in. (239.2 x 120.9 x 137.1 cm)		94.2 x 47.6 x 54 in. (239.2 x 120.9 x 137.1 cm)
	Wheelbase	60.4 in. (153.5 cm)		60.4 in. (153.5 cm)
	Ground Clearance	12 in. (30.5 cm)		12.5 in. (31.8 cm)
	Seat Height	38.6 in. (98 cm)		38.6 in. (98 cm)
	Rack Capacity	Front: 120 lb (54.4 kg) / Rear: 240 lb (109 kg)		Front: 120 lb (54.4 kg) / Rear: 240 lb (109 kg)
	Storage Capacity	9 gal (34 L)		9 gal (34 L)
	Towing Capacity	1,830 lb (830 kg)		1,830 lb (830 kg)
	Fuel Capacity	5.1 gal (19.5 L)		5.1 gal (19.5 L)
FEATURES	Gauge	4.5 in. digital display		4.5 in. digital display
	Instrumentation	N/A		USB phone charger
	Ignition	Mechanical key		Mechanical key
	Lighting	LED headlights and taillights		LED headlights and taillights
	Winch	N/A		3,500 lb (1,588 kg) winch
	Seat	Standard		Standard
	Handlebar	Standard		Standard
	Protection	Full ski plate		Front and rear bumper Full ski plate
Warranty	6-month BRP limited warranty		6-month BRP limited warranty	



Visco-Lok is a trademark of GKN Viscotek GmbH. All other trademarks are the property of their respective owners.
*Base model dry weight shown.

		OUTLANDER 850	OUTLANDER DPS 850	OUTLANDER XT 850 / 1000R	
					
COLOR OPTIONS		Viper Red	Gamete Gray	Wildland Camo Platinum Satin Foxy Red	Wildland Camo Platinum Satin Foxy Red
ENGINES	Type	850 78 hp, Rotax® 854 cc V-twin, liquid-cooled	850 78 hp, Rotax® 854 cc V-twin, liquid-cooled	850 78 hp, Rotax® 854 cc V-twin, liquid-cooled	1000R 91 hp, Rotax® 976 cc V-twin, liquid-cooled
	Fuel Delivery System	Intelligent Throttle Control (ITC) with Electronic Fuel Injection (EFI)	Intelligent Throttle Control (ITC) with Electronic Fuel Injection (EFI)	Intelligent Throttle Control (ITC) with Electronic Fuel Injection (EFI)	
	Transmission	CVT L/H/N/R/P	CVT L/H/N/R/P	CVT L/H/N/R/P	
	Drive Train	Selectable 2WD / 4WD with Visco-Lok auto-locking front differential	Selectable 2WD / 4WD with Visco-Lok QE auto-locking front differential	Selectable 2WD / 4WD with Visco-Lok QE auto-locking front differential	
	Driving Assistance	Work / Standard / Sport modes Intelligent Engine Braking (IEB)	Work / Standard / Sport modes Intelligent Engine Braking (IEB)	Work / Standard / Sport modes Intelligent Engine Braking (IEB)	
	Power Steering	N/A	Trimode Dynamic Power Steering (DPS)	Trimode Dynamic Power Steering (DPS)	
	SUSPENSIONS	Front Suspension	Arched double A-arm with front swaybar 9.2 in. (23.3 cm) travel	Arched double A-arm with front swaybar 9.2 in. (23.3 cm) travel	Arched double A-arm with front swaybar 9.2 in. (23.3 cm) travel
Front Shocks		Twin-tube	Twin-tube	Twin-tube	
Rear Suspension		Torsional Trailing Arm Independent (TTI) 9.9 in. (25.1 cm) travel	Torsional Trailing Arm Independent (TTI) 9.9 in. (25.1 cm) travel	Torsional Trailing Arm Independent (TTI) 9.9 in. (25.1 cm) travel	
Rear Shocks		Twin-tube	Twin-tube	Twin-tube	
TIRES / WHEELS	Tires	6-ply 26 x 8 / 10 x 12 in. 12 in. steel	IFP Temacross 26 x 8 / 10 x 14 in. 14 in. cast aluminum	IFP Temacross 26 x 8 / 10 x 14 in. 14 in. cast aluminum	
	Wheels				
BRAKES	Front	Dual 214 mm disc brakes with hydraulic twin-piston calipers	Dual 214 mm disc brakes with hydraulic twin-piston calipers	Dual 214 mm disc brakes with hydraulic twin-piston calipers	
	Rear	Single 214 mm disc brake with hydraulic twin-piston caliper	Single 214 mm disc brake with hydraulic twin-piston caliper	Single 214 mm disc brake with hydraulic twin-piston caliper	
DIMENSIONS / CAPACITIES	Estimated Dry Weight*	817 lb (371 kg)	817 lb (371 kg)	817 lb (371 kg)	895 lb (406 kg)
	L x W x H	86 x 48 x 49.5 in. (218.4 x 121.9 x 126 cm)	86 x 48 x 49.5 in. (218.4 x 121.9 x 126 cm)	86 x 48 x 49.5 in. (218.4 x 121.9 x 126 cm)	
	Wheelbase	51 in. (129.5 cm)	51 in. (129.5 cm)	51 in. (129.5 cm)	
	Ground Clearance	11 in. (27.9 cm)	11 in. (27.9 cm)	11 in. (27.9 cm)	
	Seat Height	34.5 in. (87.7 cm)	34.5 in. (87.7 cm)	34.5 in. (87.7 cm)	
	Rack Capacity	Front: 100 lb (45 kg) / Rear: 200 lb (90 kg)	Front: 100 lb (45 kg) / Rear: 200 lb (90 kg)	Front: 100 lb (45 kg) / Rear: 200 lb (90 kg)	
	Storage Capacity	5.7 gal (21.4 L)	5.7 gal (21.4 L)	5.7 gal (21.4 L)	
	Towing Capacity	1,650 lb (750 kg)	1,650 lb (750 kg)	1,650 lb (750 kg)	
	Fuel Capacity	5.4 gal (20.5 L)	5.4 gal (20.5 L)	5.4 gal (20.5 L)	
FEATURES	Gauge	4.5 in. digital display	4.5 in. digital display	4.5 in. digital display	
	Instrumentation	DC outlet, 15 A connector	DC outlet, 15 A connector	DC outlet, 15 A connector	
	Ignition	RF Digitally Encoded Security System (DESS)	RF Digitally Encoded Security System (DESS)	RF Digitally Encoded Security System (DESS)	
	Lighting	LED headlights	LED headlights	LED headlights	
	Winch	Pre-wired & available winch	Pre-wired & available winch	3,500 lb (1,588 kg) winch	
	Seat	Standard	Standard	Standard	
	Handlebar	Standard	Standard	Standard with wind deflectors	
	Protection	Mudguards	Mudguards	Heavy-duty front and rear bumpers Mudguards	
Warranty	6-month BRP limited warranty	6-month BRP limited warranty	6-month BRP limited warranty		



Visco-Lok is a trademark of GKN Viscotrade GmbH. All other trademarks are the property of their respective owners.
*Based on model dry weight shown.

		OUTLANDER XT-P 850 / 1000R		OUTLANDER X xc 1000R
				
COLOR OPTIONS		HyperSilver & Neo Yellow		Chalk Gray & Can-Am Red
ENGINES	Type	850	1000R	1000R
		78 hp, Rotax® 854 cc V-twin, liquid-cooled	91 hp, Rotax® 976 cc V-twin, liquid-cooled	91 hp, Rotax® 976 cc V-twin, liquid-cooled
	Fuel Delivery System	Intelligent Throttle Control (ITC) with Electronic Fuel Injection (EFI)		
	Transmission	CVT L / H / N / R / P		
	Drive Train	Selectable 2WD / 4WD / Lock 4WD with Visco-Lok front differential		
	Driving Assistance	Work / Standard / Sport modes Intelligent Engine Braking (IEB)		
Power Steering	Trimode Dynamic Power Steering (DPS)			
SUSPENSIONS	Front Suspension	Arched double A-arm with front sway bar 9.2 in. (23.3 cm) travel		
	Front Shocks	FOX 1.5 PODIUM QS3		
	Rear Suspension	Torsional trailing arm Independent (TTI) 9.9 in. (25.1 cm) travel		
	Rear Shocks	FOX 1.5 PODIUM QS3		
TIRES / WHEELS	Tires	IFP Temacross 26 x 8 / 10 x 14 in.		
	Wheels	14 in. cast-aluminum beadlock		
BRAKES	Front	Dual 214 mm disc brakes with hydraulic twin-piston calipers		
	Rear	Single 214 mm disc brake with hydraulic twin-piston caliper		
DIMENSIONS / CAPACITIES	Estimated Dry Weight*	817 lb (371 kg)	895 lb (406 kg)	895 lb (406 kg)
	L x W x H	86 x 48 x 49.5 in. (218.4 x 121.9 x 126 cm)		
	Wheelbase	51 in. (129.5 cm)		
	Ground Clearance	11 in. (27.9 cm)		
	Seat Height	34.5 in. (87.7 cm)		
	Rack Capacity	Front: 100 lb (45 kg) / Rear: 200 lb (90 kg)		
	Storage Capacity	5.7 gal (21.4 L)		
	Fuel Capacity	5.4 gal (20.5 L)		
FEATURES	Gauge	7.6 in. wide digital display		
	Instrumentation	DC outlet, 15 A connector		
	Ignition	RF Digitally Encoded Security System (DESS)		
	Lighting	LED headlights		
	Winch	3,500 lb (1,588 kg) winch		
	Seat	Standard		
	Handlebar	Aluminum taper-profile handlebar with full-wrap handguards		
	Protection	Heavy-duty front and rear bumper mudguards		
	Warranty	6-month BRP limited warranty		



Visco-Lok is a trademark of GKN Viscotekne GmbH. All other trademarks are the property of their respective owners.
*Base model dry weight shown.

	OUTLANDER Hunting Edition 850	OUTLANDER X mr 850	OUTLANDER X mr 1000R	
				
COLOR OPTIONS	Wildland Camo	Legion Red	Legion Red HyperSilver & Legion Red	
ENGINES	Type	850	1000R	
		78 hp, Rotax® 854 cc V-twin, liquid-cooled	78 hp, Rotax® 854 cc V-twin, smokeless, liquid-cooled with relocated radiator	91 hp, Rotax® 976 cc V-twin, smokeless, liquid-cooled with relocated radiator
	Fuel Delivery System	Intelligent Throttle Control (ITC) with Electronic Fuel Injection (EFI)	Intelligent Throttle Control (ITC) with Electronic Fuel Injection (EFI)	Intelligent Throttle Control (ITC) with Electronic Fuel Injection (EFI)
	Transmission	CVT L / H / N / R / P	CVT P / R / N / H / L	CVT Extra Low L / H / N / R / P
	Drive Train	Selectable 2W D / 4W D with Visco-Lok Q.E. auto-locking front differential	Selectable 2W D / 4W D / Lock 4W D with Visco-4 Lok front differential	Selectable 2W D / 4W D / Lock 4W D with Visco-4 Lok front differential
	Driving Assistance	Work / Standard / Sport modes Intelligent Engine Braking (IEB)	ECO / Standard / Sport modes Intelligent Engine Braking (IEB)	ECO / Standard / Sport modes Intelligent Engine Braking (IEB)
	Power Steering	Trimode Dynamic Power Steering (DPS)	Trimode Dynamic Power Steering (DPS)	Trimode Dynamic Power Steering (DPS)
SUSPENSIONS	Front Suspension	Arched double A-arm with front swaybar 9.2 in. (23.3 cm) travel	Arched double A-arm with front swaybar	Arched double A-arm with front swaybar
	Front Shocks	Tw in-tube	SHOW A gas shock	SHOW A gas shock
	Rear Suspension	Torsional trailing arm Independent (TTI) 9.9 in. (25.1 cm) travel	Torsional trailing arm Independent (TTI)	Torsional trailing arm Independent (TTI)
	Rear Shocks	Tw in-tube	SHOW A gas shock	SHOW A gas shock
TIRES / WHEELS	Tires Wheels	Carlisle ACT HD 26 x 8 / 10 x 12 in. 12 in. cast aluminum	ITP Cryptid 30 x 9 / 9 x 14 in. 14 in. cast aluminum	ITP Cryptid 30 x 9 / 9 x 14 in. 14 in. cast aluminum
BRAKES	Front	Dual 214 mm disc brakes with hydraulic twin-piston calipers	Dual 214 mm disc brakes with hydraulic twin-piston calipers	Dual 214 mm disc brakes with hydraulic twin-piston calipers
	Rear	Single 214 mm disc brake with hydraulic twin-piston caliper	Single 214 mm disc brake with hydraulic twin-piston caliper	Single 214 mm disc brake with hydraulic twin-piston caliper
DIMENSIONS / CAPACITIES	Estimated Dry Weight*	817 lb (371 kg)	951 lb (431 kg)	1,013 lb (459 kg)
	L x W x H	86 x 48 x 49.5 in. (218.4 x 121.9 x 126 cm)	88 x 50 x 51.5 in. (224 x 127 x 131 cm)	97 x 50 x 51.5 in. (246 x 127 x 131 cm)
	Wheelbase	51 in. (129.5 cm)	51 in. (129.5 cm)	59 in. (149.9 cm)
	Ground Clearance	12 in. (30.5 cm)	13 in. (33 cm)	13 in. (33 cm)
	Seat Height	34.5 in. (87.7 cm)	36.8 in. (93.3 cm)	36.8 in. (93.3 cm)
	Rack Capacity	Front: 100 lb (45 kg) / Rear: 200 lb (90 kg)	Rear: 200 lb (90 kg)	Rear: 200 lb (90 kg)
	Storage Capacity	5.7 gal (21.4 L)	5.7 gal (21.4 L)	5.7 gal (21.4 L)
	Towing Capacity	1,650 lb (750 kg)	1,650 lb (750 kg)	1,650 lb (750 kg)
	Fuel Capacity	5.4 gal (20.5 L)	5.4 gal (20.5 L)	5.4 gal (20.5 L)
FEATURES	Gauge	4.5 in. digital display	7.6 in. wide digital display	7.6 in. wide digital display
	Instrumentation	DC outlet, 15 A connector	DC outlet, 15 A connector	DC outlet, 15 A connector
	Ignition	RF Dually Encoded Security System (DESS)	RF Dually Encoded Security System (DESS) with cord	RF Dually Encoded Security System (DESS) with cord
	Lighting	LED headlights	LED headlights	LED headlights
	Winch	3,500 lb (1,588 kg) winch	3,500 lb (1,588 kg) winch	3,500 lb (1,588 kg) winch
	Seat	Reinforced seat skin	Standard	Standard
	Handlebar	Standard with hand deflectors and heated grips & throttle	Standard	Standard
	Protection	Heavy-duty front and rear bumpers Front, central and foot cast aluminum skid plates A-arm and TTIHM PE protectors Mudguards	Heavy-duty front and rear bumpers Mud-riding footrests Mudguards	Heavy-duty front and rear bumpers Mud-riding footrests Mudguards
	Warranty	6-month BRP limited warranty	6-month BRP limited warranty	6-month BRP limited warranty



Visco-Lok is a trademark of GKN Visco Drive GmbH. All other trademarks are the property of their respective owners.
*Base model only with eight shown.

		OUTLANDER MAX DPS 850	OUTLANDER MAX XT 850 1000R	
				
COLOR OPTIONS		Granite Gray	Platinum Satin Flare Red Wildland Camo	Platinum Satin Flare Red
ENGINES	Type	850 78 hp, Rotax® 854 cc V-twin, liquid-cooled	850 78 hp, Rotax® 854 cc V-twin, liquid-cooled	1000R 91 hp, Rotax® 976 cc V-twin, liquid-cooled
	Fuel Delivery System	Intelligent Throttle Control (ITC) with Electronic Fuel Injection (EFI)		
	Transmission	CVT L / H / N / R / P		
	Drive Train	Selectable 2WD / 4WD with Visco-Lok Q.E. auto-locking front differential		
	Driving Assistance	Work / Standard / Sport modes Intelligent Engine Braking (IEB)		
	Power Steering	Trimode Dynamic Power Steering (DPS)		
SUSPENSIONS	Front Suspension	Arched double A-arm with front sway bar 9.2 in. (23.3 cm) travel		
	Front Shocks	Tw in-tube		
	Rear Suspension	Torsional trailing arm Independent (TTI) 9.9 in. (25.1 cm) travel		
	Rear Shocks	Tw in-tube		
TIRES / WHEELS	Tires	ITP Temacross 26 x 8 / 10 x 14 in. 14 in. cast aluminum		
	Wheels	ITP Temacross 26 x 8 / 10 x 14 in. 14 in. cast aluminum		
BRAKES	Front	Dual 214 mm disc brakes with hydraulic twin-piston calipers		
	Rear	Single 214 mm disc brake with hydraulic twin-piston caliper		
DIMENSIONS / CAPACITIES	Estimated Dry Weight*	869 lb (394 kg)	869 lb (394 kg)	954 lb (433 kg)
	L x W x H	94 x 48 x 53 in. (238.8 x 121.9 x 135 cm)		
	Wheelbase	59 in. (149.9 cm)		
	Ground Clearance	11 in. (27.9 cm)		
	Seat Height	34.5 in. (87.7 cm)		
	Rack Capacity	Front: 100 lb (45 kg) / Rear: 200 lb (90 kg)		
	Storage Capacity	5.7 gal (21.4 L)		
	Towing Capacity	1,650 lb (750 kg)		
	Fuel Capacity	5.4 gal (20.5 L)		
FEATURES	Gauge	4.5 in. digital display		
	Instrumentation	DC outlet, 15 A connector		
	Ignition	RF Dignally Encoded Security System (DESS)		
	Lighting	LED headlights		
	Winch	New and available winch 3,500 lb (1,588 kg) winch		
	Seat	Convertible Rack System (CRS)		
	Handlebar	Standard with hand deflectors		
	Protection	Mudguards Heavy-duty front and rear bumper Mudguards		
	Warranty	6-month BRP limited warranty		

Visco-Lok is a trademark of GKN Viscotek GmbH. All other trademarks are the property of their respective owners.
*Base model dry weight shown.

		OUTLANDER MAX XT P 850 1000R		OUTLANDER MAX Limited 1000R
				
COLOR OPTIONS		HyperSilver & Neo Yellow		Stone Gray
ENGINES	Type	850 78 hp, Rotax® 854 cc V-twin, liquid-cooled	1000R 91 hp, Rotax® 976 cc V-twin, liquid-cooled	1000R 91 hp, Rotax® 976 cc V-twin, liquid-cooled
	Fuel Delivery System	Intelligent Throttle Control (ITC) with Electronic Fuel Injection (EFI)		Intelligent Throttle Control (ITC) with Electronic Fuel Injection (EFI)
	Transmission	CVT L / H / N / R / P		CVT L / H / N / R / P
	Drive Train	Selectable 2WD / 4WD / Lock 4WD with Visco-Lok front differential		Selectable 2WD / 4WD / Lock 4WD with Visco-Lok front differential
	Driving Assistance	Work / Standard / Sport modes Intelligent Engine Braking (IEB)		Work / Standard / Sport modes Intelligent Engine Braking (IEB)
	Power Steering	Trimode Dynamic Power Steering (DPS)		Trimode Dynamic Power Steering (DPS)
	SUSPENSIONS	Front Suspension	Arched double A-arm with front sway bar 9.2 in. (23.3 cm) travel	
Front Shocks		FOX 1.5 PODIUM QS3		FOX 1.5 PODIUM QS3
Rear Suspension		Torsional trailing arm Independent (TTI) 9.9 in. (25.1 cm) travel		Torsional trailing arm Independent (TTI) 9.9 in. (25.1 cm) travel
Rear Shocks		FOX 1.5 PODIUM QS3		FOX 1.5 PODIUM QS3
TIRES / WHEELS	Tires Wheels IFP Temacross 26 x 8 / 10 x 14 in. 14 in. cast-aluminum beadlock		M axxis Bighorn 2.0 27 x 9 / 11 x 14 in. 14 in. cast-aluminum	
BRAKES	Front	Dual 214 mm disc brakes with hydraulic twin-piston calipers		Dual 214 mm disc brakes with hydraulic twin-piston calipers
	Rear	Single 214 mm disc brake with hydraulic twin-piston caliper		Single 214 mm disc brake with hydraulic twin-piston caliper
DIMENSIONS / CAPACITIES	Estimated Dry Weight*	869 lb (394 kg)	954 lb (433 kg)	954 lb (433 kg)
	L x W x H	94 x 48 x 53 in. (2382 x 1219 x 135 cm)		94 x 48 x 53 in. (2382 x 1219 x 135 cm)
	Wheelbase	59 in. (149.9 cm)		59 in. (149.9 cm)
	Ground Clearance	11 in. (27.9 cm)		11 in. (27.9 cm)
	Seat Height	34.5 in. (87.7 cm)		34.5 in. (87.7 cm)
	Rack Capacity	Front: 100 lb (45 kg) / Rear: 200 lb (90 kg)		Front: 100 lb (45 kg) / Rear: 200 lb (90 kg)
	Storage Capacity	5.7 gal (21.4 L)		5.7 gal (21.4 L)
	Towing Capacity	1,650 lb (750 kg)		1,650 lb (750 kg)
	Fuel Capacity	5.4 gal (20.5 L)		5.4 gal (20.5 L)
FEATURES	Gauge	7.6 in. wide digital display		7.6 in. wide digital display
	Instrumentation	DC outlet, 15 A connector		DC outlet, 15 A connector
	Ignition	RF Digital Encoded Security System (DESS)		RF Digital Encoded Security System (DESS)
	Lighting	LED headlights		LED headlights
	Winch	3,500 lb (1,588 kg) winch		3,500 lb (1,588 kg) winch
	Seat	Convertible Rack System (CRS)		Convertible Rack System (CRS)
	Handlebar	Aluminum taper-profile handlebar with full wrap handguards		Standard with wind deflector
	Protection	Heavy-duty front and rear bumpers Mudguards		Heavy-duty front and rear bumpers Mudguards
	Warranty	6-month BRP limited warranty		6-month BRP limited warranty





Visco-Lok is a trademark of GKN Viscodrive GmbH. All other trademarks are the property of their respective owners.
*Base model only as shown.

		OUTLANDER MAX 6X6 DPS 450	OUTLANDER MAX 6X6 DPS 650	OUTLANDER MAX 6X6 XT 1000
				
COLOR OPTIONS		Tundra Green	Tundra Green	Boreal Green
ENGINES	Type	450 38 hp, Rotax® 427 cc single-cylinder, liquid-cooled	650 62 hp, Rotax® 650 cc V-twin, liquid-cooled	1000 82 hp, Rotax® 976 cc V-twin, liquid-cooled
	Fuel Delivery System	Electronic Fuel Injection (EFI)	Electronic Fuel Injection (EFI)	Electronic Fuel Injection (EFI)
	Transmission	CVT Extra Low L / H / N / R / P	CVT Extra Low L / H / N / R / P	CVT Extra Low L / H / N / R / P
	Drive Train	Selectable 4WD / 6WD with Visco-Lok QE auto-locking front differential	Selectable 4WD / 6WD with Visco-Lok QE auto-locking front differential	Selectable 4WD / 6WD with Visco-Lok QE auto-locking front differential
	Driving Assistance	N/A	N/A	N/A
	Power Steering	Trimode Dynamic Power Steering (DPS)	Trimode Dynamic Power Steering (DPS)	Trimode Dynamic Power Steering (DPS)
	SUSPENSIONS	Front Suspension	Double A-arm 9 in. (22.9 cm) travel	Arched double A-arm with front swaybar 9.2 in. (23.3 cm) travel
Front Shocks		Tw in-tube	Tw in-tube	Tw in-tube
Rear Suspension		Double Torsion Trailing Arm Independent (TTI) with quick-release swaybar 8.8 in. (22.4 cm) travel	Double Torsion Trailing Arm Independent (TTI) with quick-release swaybar 9.9 in. (25.1 cm) travel	Double Torsion Trailing Arm Independent (TTI) with quick-release swaybar 9.9 in. (25.1 cm) travel
Rear Shocks		Tw in-tube	Tw in-tube	Tw in-tube
TIRES / WHEELS	Tires Wheels	Carlisle ACT HD 26 x 8 / 10 x 12 in. 12 in. cast aluminum	ITP Temacross 26 x 8 / 10 x 14 in. 14 in. cast aluminum	ITP Temacross 26 x 8 / 10 x 14 in. 14 in. cast aluminum
BRAKES	Front	Dual 214 mm disc brakes with hydraulic twin-piston calipers	Dual 214 mm disc brakes with hydraulic twin-piston calipers	Dual 214 mm disc brakes with hydraulic twin-piston calipers
	Rear	Single 214 mm disc brake with hydraulic twin-piston caliper	Dual 214 mm disc brakes with hydraulic twin-piston calipers	Dual 214 mm disc brakes with hydraulic twin-piston calipers
DIMENSIONS / CAPACITIES	Estimated Dry Weight*	1,000 lb (454 kg)	1,100 lb (499 kg)	1,170 lb (531 kg)
	L x W x H	118 x 46 x 57 in. (300 x 117 x 145 cm)	124.8 x 48.5 x 55.3 in. (317 x 123 x 140 cm)	124.8 x 48.5 x 55.3 in. (317 x 123 x 140 cm)
	Wheelbase	90 in. (228.5 cm)	90 in. (228.5 cm)	90 in. (228.5 cm)
	Ground Clearance	10.5 in. (26.7 cm)	11 in. (27.9 cm)	11 in. (27.9 cm)
	Seat Height	33.8 in. (85.8 cm)	34.5 in. (87.7 cm)	34.5 in. (87.7 cm)
	Rack Capacity	Front: 120 lb (54.4 kg) / Rear: 350 lb (159 kg)	Front: 100 lb (45 kg) / Rear: 700 lb (318 kg)	Front: 100 lb (45 kg) / Rear: 700 lb (318 kg)
	Storage Capacity	2.9 gal (10.9 L)	Dual-level cargo box with side walls and tailgate 18.5 gal (70 L)	Dual-level cargo box with side walls and tailgate 18.5 gal (70 L)
	Towing Capacity	1,650 lb (750 kg)	1,650 lb (750 kg)	1,650 lb (750 kg)
	Fuel Capacity	5.4 gal (20.5 L)	5.4 gal (20.5 L)	5.4 gal (20.5 L)
FEATURES	Gauge	4.5 in. digital display	4.5 in. digital display	4.5 in. digital display
	Instrumentation	DC outlet, 15 A connector	DC outlet, 15 A connector	DC outlet, 15 A connector
	Ignition	RF Digitally Encoded Security System (DESS)	RF Digitally Encoded Security System (DESS)	RF Digitally Encoded Security System (DESS)
	Lighting	70 W headlights	LED headlights	LED headlights
	Winch	Pre-wired for available winch	Pre-wired for available winch	3,500 lb (1,588 kg) winch
	Seat	Convertible Rack System (CRS)	Convertible Rack System (CRS)	Convertible Rack System (CRS)
	Handlebar	Standard	Standard	Standard with hand deflectors
	Protection	N/A	N/A	Heavy-duty front bumper
	Warranty	6-month BRP limited warranty	6-month BRP limited warranty	6-month BRP limited warranty

Visco-Lok is a trademark of GKN ViscoDrive GmbH. All other trademarks are the property of their respective owners.
*Base model dry weight shown.

	RENEGADE 650	RENEGADE X xc 1000R	RENEGADE X mr 650	RENEGADE X mr 1000R	
					
COLOR OPTIONS	Catalyst Gray	Catalyst Gray & Neo Yellow	Catalyst Gray & Neo Yellow	Catalyst Gray & Neo Yellow HyperSilver & Legion Red	
ENGINES	Type	650	1000R	650	1000R
		62 hp, Rotax® 650 cc V-twin, liquid-cooled	91 hp, Rotax® 976 cc V-twin, liquid-cooled	62 hp, Rotax® 650 cc V-twin, smokeless, liquid-cooled	91 hp, Rotax® 976 cc V-twin, smokeless, liquid-cooled
	Fuel Delivery System	Intelligent Throttle Control (ITC) with Electronic Fuel Injection (EFI)	Intelligent Throttle Control (ITC) with Electronic Fuel Injection (EFI)	Intelligent Throttle Control (ITC) with Electronic Fuel Injection (EFI)	Intelligent Throttle Control (ITC) with Electronic Fuel Injection (EFI)
	Transmission	CVT L/H/N/R/P	CVT L/H/N/R/P	CVT L/H/N/R/P	CVT Extra Low L/H/N/R/P
	Drive Train	Selectable 2WD / 4WD with Visco-Lok auto-locking front differential	Selectable 2WD / 4WD with Visco-Lok QE auto-locking front differential	Selectable 2WD / 4WD / Lock 4WD with Visco-4 Lok front differential	Selectable 2WD / 4WD / Lock 4WD with Visco-4 Lok front differential
	Driving Assistance	Work / Standard / Sport modes Intelligent Engine Braking (IEB)	Work / Standard / Sport modes Intelligent Engine Braking (IEB)	Work / Standard / Sport modes Intelligent Engine Braking (IEB)	Work / Standard / Sport modes Intelligent Engine Braking (IEB)
	Power Steering	N/A	Trimode Dynamic Power Steering (DPS)	Trimode Dynamic Power Steering (DPS)	Trimode Dynamic Power Steering (DPS)
SUSPENSIONS	Front Suspension	Arched double A-arm with front swaybar 9.2 in. (23.3 cm) travel	Arched double A-arm with front swaybar 9.2 in. (23.3 cm) travel	Arched double A-arm with front swaybar	Arched double A-arm with front swaybar
	Front Shocks	SHOW A gas shock	FOX 1.5 PODIUM RC2	SHOW A gas shock	FOX 1.5 PODIUM QS3
	Rear Suspension	Torsional Trailing arm Independent (TTI) 9.9 in. (25.1 cm) travel	Torsional Trailing arm Independent (TTI) 9.9 in. (25.1 cm) travel	Torsional Trailing arm Independent (TTI)	Torsional Trailing arm Independent (TTI)
	Rear Shocks	SHOW A gas shock	FOX 1.5 PODIUM RC2	SHOW A gas shock	FOX 1.5 PODIUM QS3
TIRES / WHEELS	Tires	ITP Holeshot ATR 25 x 8 / 11 x 12 in. 12 in. cast aluminum	ITP Holeshot ATR 25 x 8 / 11 x 12 in. 12 in. cast aluminum beadlock	ITP MegaM ayhem 28 x 8 / 10 x 12 in. 12 in. cast aluminum beadlock	ITP Cryptid 30 x 9 / 9 x 14 in. 14 in. cast aluminum beadlock
	Wheels				
BRAKES	Front	Dual 214 mm disc brakes with hydraulic twin-piston calipers	Dual 214 mm disc brakes with hydraulic twin-piston calipers	Dual 214 mm disc brakes with hydraulic twin-piston calipers	Dual 214 mm disc brakes with hydraulic twin-piston calipers
	Rear	Single 214 mm disc brake with hydraulic twin-piston caliper	Single 214 mm disc brake with hydraulic twin-piston caliper	Single 214 mm disc brake with hydraulic twin-piston caliper	Single 214 mm disc brake with hydraulic twin-piston caliper
DIMENSIONS / CAPACITIES	Estimated Dry Weight*	750 lb (340 kg)	795 lb (361 kg)	870 lb (395 kg)	971 lb (440 kg)
	L x W x H	86 x 48 x 49 in. (218.4 x 121.9 x 124 cm)	86 x 48 x 49 in. (218.4 x 121.9 x 124 cm)	83 x 50 x 56 in. (224 x 127 x 131 cm)	83 x 50 x 56 in. (224 x 127 x 131 cm)
	Wheelbase	51 in. (129.5 cm)	51 in. (129.5 cm)	51 in. (129.5 cm)	51 in. (129.5 cm)
	Ground Clearance	10.5 in. (26.7 cm)	10.5 in. (26.7 cm)	12 in. (30.5 cm)	12.5 in. (31.8 cm)
	Seat Height	34.5 in. (87.7 cm)	34.5 in. (87.7 cm)	35.3 in. (89.5 cm)	36.8 in. (93.3 cm)
	Rack Capacity	Rear: 35 lb (16 kg)	Rear: 35 lb (16 kg)	Rear: 35 lb (16 kg)	Rear: 35 lb (16 kg)
	Storage Capacity	N/A	N/A	N/A	N/A
	Towing Capacity	1,300 lb (590 kg)	1,300 lb (590 kg)	1,300 lb (590 kg)	1,300 lb (590 kg)
	Fuel Capacity	5.4 gal (20.5 L)	5.4 gal (20.5 L)	5.4 gal (20.5 L)	5.4 gal (20.5 L)
FEATURES	Gauge	4.5 in. digital display	4.5 in. digital display	4.5 in. digital display	4.5 in. digital display
	Instrumentation	DC outlet, 15 A connector	DC outlet, 15 A connector	DC outlet, 15 A connector	DC outlet, 15 A connector
	Ignition	RF Dually Encoded Security System (DESS.)	RF Dually Encoded Security System (DESS.)	RF Dually Encoded Security System (DESS.) with coil	RF Dually Encoded Security System (DESS.) with coil
	Lighting	LED headlights	LED headlights	LED headlights	LED headlights
	Winch	Pre-wired & available w/inch	Pre-wired & available w/inch	Pre-wired & available w/inch	3,500 lb (1,588 kg) w/inch
	Seat	Standard	Standard	Standard	Standard
	Handlebar	Standard	Aluminum taper-profile handlebar with full wrap handguards	Aluminum taper-profile handlebar with grab handle and full wrap handguards	Aluminum taper-profile handlebar with grab handle and full wrap handguards
	Protection	Front bumper	Front bumper Front and central skid plate	Front and rear bumpers Mudguards Front and central aluminum skid plate	Front and rear bumpers Mudguards Front and central aluminum skid plate
	Warranty	6-month BRP limited warranty	6-month BRP limited warranty	6-month BRP limited warranty	6-month BRP limited warranty

Visco-Lok is a trademark of GKN Visco Drive GmbH. All other trademarks are the property of their respective owners.
*Base model dry weight shown.

		RENEGADE 70 EFI	RENEGADE 110 EFI	RENEGADE X xc 110 EFI	DS 250
					
COLOR OPTIONS		Catalyst Gray & Neo Yellow Iceberg Blue & Black	Catalyst Gray & Neo Yellow Iceberg Blue & Black	Black & Legion Red	Black & Can-Am Red
ENGINES	Type	70 EFI	110 EFI	110 EFI	250
		4-stroke single-cylinder, air-cooled	112 cc 4-stroke single-cylinder, air-cooled	112 cc 4-stroke single-cylinder, air-cooled	250 cc 4-stroke single-cylinder, liquid-cooled
	Fuel Delivery System	Electronic Fuel Injection (EFI) with built-in throttle limiter	Electronic Fuel Injection (EFI) with built-in throttle limiter	Electronic Fuel Injection (EFI) with built-in throttle limiter	Carburetion
	Transmission	CVT F / N / R	CVT F / N / R	CVT F / N / R	CVT F / N / R
	Drive Train	Chain driven / 2W D Electric starting system	Chain driven / 2W D Electric starting system	Chain driven / 2W D Electric starting system	Chain driven / solid axle
	Driving Assistance	N/A	N/A	N/A	N/A
	Power Steering	N/A	N/A	N/A	N/A
SUSPENSIONS	Front Suspension	Single A-arm 5 in. (12.7 cm) travel	Single A-arm 5 in. (12.7 cm) travel	Double A-arm 5.5 in. (14 cm) travel	Double A-arm 5.5 in. (14 cm) travel
	Front Shocks	Tw in-tube	Tw in-tube	Gas with piggyback reservoirs	Tw in-tube
	Rear Suspension	Sw ingam 6 in. (15.2 cm) travel	Sw ingam 6 in. (15.2 cm) travel	Sw ingam 6 in. (15.2 cm) travel	Sw ingam 6.7 in. (17 cm) travel
	Rear Shocks	Tw in-tube	Tw in-tube	Gas	Tw in-tube
TIRES / WHEELS	Tires	17 x 7 / 8 x 8 in. 8 in. steel	Front: 19 x 7 x 8 in. Rear: 18 x 9.5 x 8 in. 8 in. steel	Front: 19 x 7 x 8 in. Rear: 18 x 9.5 x 8 in. 8 in. steel	Front: Kenda 22 x 7 x 10 in. Rear: Kenda 20 x 11 x 9 in. Front: 10 in. silver steel / Rear: 9 in. silver steel
	Wheels				
BRAKES	Front	Dual drum brakes	Dual drum brakes	Dual drum brakes	Dual hydraulic disc brakes
	Rear	Single drum brakes	Single drum brakes	Single drum brakes	Single hydraulic disc brake
DIMENSIONS / CAPACITIES	Estimated Dry Weight*	290 lb (130 kg)	295 lb (134 kg)	310 lb (140 kg)	429 lb (195 kg)
	L x W x H	59 x 38 x 36 in. (150 x 97 x 92 cm)	60.6 x 40.4 x 38.6 in. (154 x 103 x 98 cm)	60.6 x 42 x 38.6 in. (154 x 108 x 98 cm)	72 x 40.5 x 43.5 in. (183 x 103 x 110.5 cm)
	Wheelbase	39 in. (99 cm)	41 in. (105 cm)	41 in. (105 cm)	47 in. (118.7 cm)
	Ground Clearance	7.3 in. (18.5 cm) under frame / 3.5 in. (9 cm) under rear axle	8.3 in. (21.1 cm) under frame / 4.5 in. (11.4 cm) under rear axle	8.3 in. (21.1 cm) under frame / 4.5 in. (11.4 cm) under rear axle	10.2 in. (26 cm) center of ATV
	Seat Height	26 in. (68 cm)	28 in. (71 cm)	28 in. (71 cm)	31.5 in. (80 cm)
	Rack Capacity	N/A	N/A	N/A	N/A
	Storage Capacity	N/A	N/A	N/A	N/A
	Towing Capacity	N/A	N/A	N/A	N/A
	Fuel Capacity	1.6 gal (6 L)	1.6 gal (6 L)	1.6 gal (6 L)	3.3 gal (12.5 L)
FEATURES	Gauge	Neutral, reverse, fuel level and check engine lights	Neutral, reverse, fuel level and check engine lights	Neutral, reverse, fuel level and check engine lights	Neutral, light, reverse light and oil/tem perature light
	Instrumentation	N/A	N/A	N/A	N/A
	Ignition	Mechanical key	Mechanical key	Mechanical key	Mechanical key
	Lighting	Halogen running headlights	Halogen running headlights	Halogen running headlights	2 headlamps (65 W) with tail light and brake light
	Winch	N/A	N/A	N/A	N/A
	Seat	Standard	Standard	Standard	Standard
	Handlebar	Ergonom ics and controls sized for 6 years old and up	Ergonom ics and controls sized for 10 years old and up	Sport handguards Ergonom ics and controls sized for 10 years old and up	Standard
	Protection	Front bumper Removable footboard spacers	Front bumper	Front bumper	N/A
	Warranty	6-month BRP limited warranty	6-month BRP limited warranty	6-month BRP limited warranty	6-month BRP limited warranty

Visco-Lok is a trademark of GKN ViscoDrive GmbH. All other trademarks are the property of their respective owners.
*Base model dry weight shown.



G2, G2L, G2S ACCESSORIES

G2, G2L, G2S ACCESSORIES

LinQ :Easy On,Easy Off Cargo	44
Racks & Holders	49
Cargo & Storage	50
Can-Am Windshields	52
Handlebars & Mirrors	53
Seats	54
HMWPE Skid Plates	55
Aluminum Skid Plates	56
HMWPE & Aluminum Skid Plates	58
Bumpers & Guards	59
Lights & Electrical	62
Winches	65
Hitches	67
Performance	68
Covers, Decals & Add-Ons	70
Apache Track Systems	72
ProMount Powers	74



BUNDLE UP TO NEVER COMPROMISE YOUR ATV BUNDLES

STEP 1: CHOOSE YOUR ESSENTIAL BUNDLE

		G2L G2L MAX	G2 G2 MAX
STARTER	LinQ Base	715002350	N/A
	LinQ 23 Gal (86 L) Trunk Box	715004923	715004923
	Handlebar Wind Deflectors	715001706	715001706
ADVANCED	LinQ Heavy-Duty Basket	715001215	715001215
	LinQ ToolKit	715006829	715006829
	Handlebar Mirrors	715005366	715005366
PEAK	Bluetooth Handlebar Soundbar by M TX	219400840	219400840

STEP 2: PICK YOUR ADD-ON BUNDLE

		G2L G2L MAX	G2 G2 MAX
ADVENTURE	Self-Cleaning Footwells	715004759	715004759
	Electronic Device Holder	715004919	715004919
	Storage 2.6 Gal (10 L) Bag	269502121	269502121
	Fender Flares	715001909	N/A
	Mud Flaps	N/A	715007089
HUNT	LinQ Gear Grips	715005340	715005340
	Gun Boot Rack	715001918	715002113
	Gun Boot 6.0 Inch by Kopin	715001419	715001419
	Expedition Front Bumper	715007233	715007233
WORK	Large Cargo Box	715007001	715007001
	LinQ Tool Holder	715007358	715007358
	USB Power Outlet Kit	219400510	219400510
	Ratchet Tie-Downs	715008309	715008309
WINTER	Seat Heater	715007211	715007211
	Heavy-Duty Seat Cover	715007212	715007212
	High Windshield Kit	715006382	715006382

* 2023 Bombarrier Recreational Products Inc. All rights reserved. ®, TM and the BRP logo are trademarks of Bombarrier Recreational Products Inc. or its affiliates. Because of its ongoing commitment to product quality and innovation, BRP reserves the right, at any time, to discontinue or change specifications, prices, designs, features, models or equipment without incurring any obligation.

LINQ EASY ON, EASY OFF CARGO



LinQ ACCESSORIES

Compatibility/requirements

<ul style="list-style-type: none"> • No tools needed: Quickly install and remove accessories by hand. • Equip your Can-Am for specialized tasks in no time. • Sturdy mounting system that holds up to the roughest terrain. 	OUTLANDER 450/570	OUTLANDER	FENEGADE
LinQ Accessories with 16" Base <ul style="list-style-type: none"> • LinQ anchors mounted 16 inches apart, center-to-center. • Lower loading capacity than the LinQ with 36" base accessories. • Can be used on Can-Am ATV and SxS vehicles, Can-Am Spyder and Ryker vehicles, Sea-Doo watercraft and SkiDoo snowmobiles. 			
LinQ 4.2 Gal (16 L) Cooler 219400964 • Black / 295100698 • White			
LinQ Tool Box 715008111			LinQ Luggage Rack 715001734
LinQ SR 5.5 Gal (21 L) Bag 860202449			& LinQ Anchor Adapter Kit 715004960
LinQ 4.5 Gal (17 L) Sport Bag 860202447	LinQ Adapter Plate 715007273 & LinQ Base Installation Kit 715008125	LinQ Anchor Adapter Kit 715004960 & LinQ Base Installation Kit 715008125	OR
LinQ Modular Box 715005494 • (10 L) 715007112 • (20 L) 715006830 • (30 L)			LinQ Adapter Plate 715007274 & LinQ Base Installation Kit 715008125
LinQ Tool Kit 715006829			
LinQ Roll-Top Bag 715008110			
LinQ Accessories with 36" Base <ul style="list-style-type: none"> • Mount on LinQ racks often used by Can-Am ORV vehicles. • Higher loading capacity than the LinQ with 16" base accessories. • Usage is limited to Can-Am ORV vehicles. 			
LinQ 12 Gal (45 L) Cargo Box 715003879	LinQ Base 715002350		
LinQ 23 Gal (86 L) Trunk Box 715004923			
LinQ 32 Gal (121 L) Trunk Box 715001747 (L-up) 715001749 (MAX)	No compatibility		
LinQ 11.5 Gal (43 L) Audio Cargo Box 715003018	LinQ Base 715002350	No further requirements	LinQ Luggage Rack 715001734
LinQ 8 Gal (30 L) Cooler Box 715004778 • Black / 715004698 • Gray	No compatibility		
LinQ Premium Storage Bag by OGIO 715002923 • Black			
LinQ Heavy Duty Basket 715001215	LinQ Base 715002350		
LinQ Low Profile Basket 715004282			
LinQ Holders			
LinQ 4" (10 cm) Rack Extension 715001711 • Silver / 715001665 • Black	Not compatible *Alternative 5" or 8" Rack Extension #14001913 or 715001914 are available for G2L	Rack	
LinQ 6" (15 cm) Rack Extension 715001712 • Silver / 715001671 • Black			LinQ Luggage Rack 715001734
LinQ Mounted Gear Grips 715005340	LinQ Base 715002350	No further requirements	
LinQ Tool Holder 715007358			
LinQ Gun Boot Rack 715002112 715002113	Not compatible *Alternative Gun Boot Racks (715001918 or 715001919) are available for G2L		No compatibility

LinQ Accessories with 16" Base

LinQ Modular Box	G2,G2L,G2S	715005494 • (10 L)	\$139.99
		715007112 • (20 L)	\$159.99
		715006830 • (30 L)	\$179.99



- Allows stacking of other modular boxes to always have the right gear accessible.
- Always have the right box size to fit everything.
- Can be installed on any LinQ Base with a 16" width.
- See table for installation location and requirements.

Thermal Insert for LinQ Modular Box (10 L)	G2,G2L,G2S	219401110	\$55.99
---	------------	-----------	---------



- Insulated liner.
- Fits very well in the LinQ Modular Box (10 L).
- Can contain seven 355 mL cans.
- Keeps ice cold for one day.
- Interior dimensions: 9"L x 17"W x 2"H.

LinQ Tool Kit	G2,G2L,G2S	715006829	\$309.99
----------------------	------------	-----------	----------



- Includes:
 - Cutter pliers
 - Long-nose pliers
 - Locking pliers
 - Ratchet wrench "drive
 - 6" ratchet extension
 - Integrated CVT belt storage location (belt not included)
 - Long-socket 19 mm "drive -6 pts
 - Socket 18 mm "drive
 - Long-socket 17 mm "drive -6 pts
 - Socket 15 mm "drive
 - Socket 13 mm "drive
 - Socket 10 mm "drive
 - Socket 8 mm "drive
 - Combined wrench 19 mm
 - Combined wrench 18 mm
 - Combined wrench 15 mm
 - Combined wrench 13 mm
 - Combined wrench 10 mm
 - Combined wrench 8 mm
 - Socket Torx T40 "drive
 - Socket Torx T30 "drive
 - Socket Torx T20 "drive
 - Breaker bar "drive
- See table for installation location and requirements.

LinQ 4.2 Gal (16 L) Cooler	G2,G2L,G2S	■ 219400964 • Black	\$369.99
		■ 295100698 • White	



- All the benefits of LinQ: simple, fast and secure.
- Rotomolded construction for exceptional rigidity and durability.
- Premium-quality foam insulation for optimal ice retention.
- Uses LinQ mounting system (Patent US 8777531 and US 8875830).
- Easy one-second on/off toolless system.
- Can contain twenty 355 mL cans.
- Keeps ice cold for three days.
- Exterior dimensions: 13"L x 20"W x 10"H.
- Interior dimensions: 9"L x 17"W x 7"H.
- See table for installation location and requirements.

LinQ Tool Box	G2,G2L,G2S	715008111	\$174.99
----------------------	------------	-----------	----------



- High precision injection HDPE construction provides rigidity and durability.
- 5 gal (19 L) maximum capacity.
- Weather-resistant, sealed and lockable cover.
- Manufactured for saltwater purposes.
- See table for installation location and requirements.

LinQ Roll-Top Bag	G2,G2L,G2S	715008110	\$229.99
--------------------------	------------	-----------	----------



- Fully waterproof Roll-Top dry bag will securely store and confine your equipment.
- LinQ mounted using heavy-duty rigid plastic base.
- High capacity storage solution 10.6 gal (40 L).
- Bottom foam liner for additional equipment protection.
- Integrated handle for easy transportation on/off the vehicle.
- Manufactured for saltwater purposes.
- Dimensions: 14"L x 19"W x adjustable H.
- See table for installation location and requirements.

SR 5.5 Gal (21 L) LinQ Bag	G2,G2L,G2S	860202449	\$224.99
-----------------------------------	------------	-----------	----------



- Semirigid expandable bag.
- 5.5 gal (21 L) capacity.
- See table for installation location and requirements.

LinQ 4.5 Gal (17 L) Sport Bag	G2,G2L,G2S	860202447	\$204.99
--------------------------------------	------------	-----------	----------



- 4.5 gal (17 L) capacity.
- Rigid bottom, semirigid top.
- See table for installation location and requirements.

LinQ Accessories with 36" Base

LinQ 12 Gal (45 L) Cargo Box	G2 (front only for 6x6 & MAX models 2013-2014),G2L,G2S	715003879	\$319.99
-------------------------------------	--	-----------	----------



- LinQ mounted for easy on, easy off installation.
- Holds cargo safely and securely while riding.
- See table for installation location and requirements.

LinQ 23 Gal (86 L) Trunk Box	G2 (except 6x6 models),G2L,G2S	715004923	\$369.99
-------------------------------------	--------------------------------	-----------	----------



- LinQ mounted for easy on, easy off installation.
- Lockable and weather-resistant.
- Holds cargo safely and securely while riding.
- Comes with footpads for passenger.
- See table for installation location and requirements.

LinQ 32 Gal (121 L) Trunk Box	G2 (except MAX models & 6x6),G2S	715001747	\$539.99
	European Version (EC compliant)	715001748 •No rear tail light.	\$489.99



- LinQ Retrofit Adapter Plate (715001334) is required for G1 models.
- Trunk Box Panels available in many colors to match your vehicle (sold separately).
- See table for installation location and requirements.

LinQ 32 Gal (121 L) Trunk Box for Outlander Max	G2 MAX models only (except 6x6 models)	715001749	\$629.99
	European Version (EC compliant)	715001750 •No rear tail light.	



- Passenger comfort is ensured on active rides as well as longer recreational rides thanks to the ergonomically designed passenger padding, which is comfort-fitted with a portion made of closed cell foam that won't absorb water.
- Very easy to embark even when driver is seated.
- Trunk Box Panels available in many colors to match your vehicle (sold separately).

LinQ 32 Gal (121 L) Trunk Box Panels	G2 (except 6x6 models),G2S	\$59.99
---	----------------------------	---------



- Color panels to match the LinQ 32 Gal (121 L) Trunk Box to your vehicle.

■ 715001391 •Black	■ 715002985 •Manta Green
■ 715001392 •Yellow	■ 715002986 •Can-Am Red
■ 715001395 •Viper Red	■ 715006119 •Orange Crush
□ 715002481 •White	■ 715006120 •Squadron Green
■ 715002480 •Light Gray	■ 715007074 •Tundra Green
■ 715002984 •Octane Blue	

LinQ 32 Gal (121 L) Trunk Box Panels
(Not illustrated)

EUROPEAN VERSION EC compliant

\$59.99

- Covers panels to match the LinQ 32 Gal (121 L) Trunk Box to your vehicle.
- No rear tail light.

- | | |
|-------------------------------|----------------------------------|
| ■ 715001397 •Black | ■ 715006122 •Manta Green |
| ■ 715001398 •Yellow | ■ 715006121 •Camaro Red |
| ■ 715006124 •Viper Red | ■ 715006123 •Orange Crush |
| □ 715002483 •White | |

LinQ 11.5 Gal (43 L) Audio Cargo Box

G2 (front only for 6x6 & MAX models 2013-2014), G2L, G2S

715003018

\$759.99



- Mounts on/off easily to hold/carry cargo safely and securely.
- The Bluetooth enabled receiver and 6.5" (16.5 cm) speakers are smartly concealed and integrated in the cover.
- Automatic shut-off function protects your battery by turning the system off after 10 minutes of inactivity.
- Backlit control panel perfect for night riding.
- Water-resistant speakers.
- Delivers the best sound quality on the market to sweeten your ride courtesy of a built-in full range high-efficiency amplifier.
- See table for installation location and requirements.

LinQ 8 Gal (30 L) Cooler Box

G2 (except 6x6 models), G2S

- | |
|---------------------------|
| ■ 715004778 •Black |
| ■ 715004698 •Gray |

\$439.99



- LinQ mounted for easy on, easy off installation.
- Rotomolded construction provides exceptional rigidity and durability.
- Premium-quality foam insulation for optimal retention.
- Integrated, fully-removable compartment protects food.
- Robust rubber latches keep the cover tightly closed.
- Weather-resistant.
- Convenient drain plug.
- See table for installation location and requirements.

LinQ Premium Storage Bag by OGIO

G2 (except 6x6 models), G2L, G2S

■ **715002923** •Black

\$439.99



- LinQ mounted for easy on, easy off installation.
- Holds cargo safely and securely while riding.
- See table for installation location and requirements.

LinQ Low Profile Basket

G2, G2L (front only for MAX & 6x6 models), G2S

715004282

\$209.99



- Low profile, open basket increases cargo space.
- Perfect for easy access to tools, rope, winch and power accessories.
- Multiple bungee cord and tie-down anchor points.
- Made of impact-resistant injected polypropylene.
- See table for installation location and requirements.

LinQ Heavy-Duty Basket

G2, G2L (front only for MAX & 6x6 models), G2S

715001215

\$269.99



- Made of high-strength, low-alloy steel.
- LinQ mounted for easy on, easy off installation.
- Can be placed on both front and back racks of vehicle.
- See table for installation location and requirements.

Large Cargo Box

G2, G2L (except 6x6)

715007001

\$639.99



- Rear bed to carry large items.
- Anchor points (D-ring), LinQ fixtures for tool holder, and marks to allow the installation of a 16" accessory.
- Also has a mark for the floor and slot to enable the installation of a divider and a slot for a divider to close the recess on the rear vertical lip.
- It is installed on ATV platforms through the LinQ system and hooks to make it easily installable and removable.

LinQ Holders

LinQ Tool Holder

G2,G2L,G2S

715007358

\$54.99



- Ultra-versatile toolholder.
- Convenient swivelhatch allows tools to be stored in any orientation.
- Sold in pairs.

LinQ Gear Grips

G2,G2L,G2S

715005340

\$144.99



- Durable and flexible grips provide a custom fit for a variety of items from 1" to 4" (2.5 cm to 10 cm) in diameter.
- Heavy-duty design for carrying bows, fishing poles, rakes, farm tools and more.
- Quick-release button opens grip quickly for easy access to gear.
- Heavy-duty base system built for the toughest adventures.
- Make transporting your tools a snap by combining the Gear Grips with the LinQ system.
- 360° orientation.
- Sold in pairs.

LinQ Mounting

LinQ Anchor Adapter Kit

G2,G2S

715004960

\$75.99



- Allows the installation of accessories with LinQ Base of 1.6" on LinQ racks.
- Toolless installation and removal.
- For G2S, the LinQ Luggage Rack (715001734) is required for installation.

LinQ Base

G2L

715002350

\$24.49



- Made of glass fiber reinforced polypropylene.
- Allows you to install LinQ accessories.
- Sold in pack of 4.

LinQ Lock

G2,G2L,G2S

860201968

\$61.99



- Simple way to securely lock most LinQ accessories.
- Lock cover protects lock from the elements.
- Corrosion resistant.
- Pack of 1, includes 2 keys.
- Not compatible with LinQ 4.2 US Gal (16 L) Cooler, LinQ Toolbox, LinQ Tool Holder and LinQ Gear Grips.

LinQ Replacement Parts

715001707

\$27.99



- Unique mounting fastener usable on any LinQ system accessory.
- Toolless installation and removal.
- Sold in pairs.

RACKS & HOLDERS

LinQ Rack Extension 4" (10 cm)	G2, G2S	■ 715001711 • Silver ■ 715001665 • Black	\$234.99
	<ul style="list-style-type: none"> • Fits front/rear. • Strong and durable. • Helps keep cargo securely in place. • Easy and toolless installation thanks to the LinQ system. • Anti-corrosion coating with durable powdercoat finish. • LinQ Luggage Rack (715001734) is required for G2S. 		
LinQ Rack Extension 6" (15 cm)	G2, G2S	■ 715001712 • Silver ■ 715001671 • Black	\$249.99
	<ul style="list-style-type: none"> • Fits front/rear. • Strong and durable. • Helps keep cargo securely in place. • Easy and toolless installation thanks to the LinQ system. • Anti-corrosion coating with durable powdercoat finish. • LinQ Luggage Rack (715001734) is required for G2S. 		
Rack Extension 5" (13 cm)	G2L	715001913	\$139.99
	<ul style="list-style-type: none"> • Fits front/rear. • Made of carbon steel. • Provides tie-down points to secure cargo on racks. • Easy installation on tubular rack. • Anti-corrosion coating with durable powdercoat finish. 		
Rack Extension 8" (20 cm)	G2L	715001914	\$159.99
	<ul style="list-style-type: none"> • Fits front/rear. • Made of carbon steel. • Provides tie-down points to secure cargo on racks. • Easy installation on tubular rack. • Anti-corrosion coating with durable powdercoat finish. 		
LinQ Luggage Rack	G2S (except X m models)	715001734	\$319.99
	<ul style="list-style-type: none"> • Bolt-on rack. • Enables use of LinQ mounted accessories on the G2S. 		
LinQ Base Plate	G2L	715007273	\$114.99
	<ul style="list-style-type: none"> • Enables use of 16" wide LinQ Base accessories on G2L to extend cargo options and journey opportunities. • Requires LinQ Base Kit (715008125). 		
LinQ Base Plate	G2S	715007274	\$149.99
	<ul style="list-style-type: none"> • Enables use of 16" wide LinQ Base accessories on G2S to extend cargo options and journey opportunities. • Requires LinQ Base Kit (715008125). 		

Gun Boot Rack	G2L (except M AX models)	715001918	\$154.99
	G2L (M AX models only)	715001919	



- Made of steel.
- Designed for the tubular rack.
- For use with Gun Boot 6.0 Impact by Kolpin.
- Can be mounted to either side of the vehicle.

Gun Boot 6.0 Impact¹ by Kolpin¹	G2, G2L	715001419	\$109.99
--	---------	-----------	-----------------



- Extra room for pistol grip-type weapons and small pods.
- Easily fits firearms up to 51" (130 cm) in total length.
- Provides ample room for 2" (60 mm) scopes.
- Hatchback design allows easy access.
- Ergonomically designed handle and molded attachment points for sling.
- Snap-close cover with locking capability.
- Designed to accommodate left and right hand bolt-action rifles and shotguns.
- Includes removable, shock absorbing foam and nylon impact liner for superior interior protection.
- Requires appropriate mounting kit for installation.

LinQ Gun Boot Rack (Not illustrated)	G2 (except M AX, 6x6 & X m r1000)	715002112	\$184.99
	G2 (M AX & X m r1000 models only)	715002113	\$144.99

- This lightweight Gun Boot Rack can be mounted on either side of your Outlander using the toolless LinQ system.
- For use with Gun Boot 6.0 Impact by Kolpin.

Multi-Fit Holder	G2, G2L	715002354 • Single	\$62.99
		715001945 • Double	\$89.99



- Open U-shaped bracket for carrying tools (shovel, axe) and hunting weapons (rifle, bow) that are safely secured, but easily accessible.
- Easy installation on tubular rack, extension racks, basket or bumper.
- For G2, the LinQ Rack Extension (715001711) is required.
- Sold in pairs.

LinQ Gear Grips	G2L	715001421	\$87.99
------------------------	-----	-----------	----------------



- Durable, flexible grips cushion and protect while providing a custom fit for a variety of items from 1" to 4" (2.5 cm to 10 cm) in diameter.
- Heavy-duty design for carrying bows, fishing poles, rakes, farm tools and more.
- Quick-release button opens grip quickly for easy access to gear.
- Heavy-duty base system built for the toughest adventures.
- Easy installation on tubular racks, extension racks, brackets or bumper.
- Sold in pairs.

CARGO & STORAGE



Log Bars	G2 (6x6 models only)	715001987	\$1,159.99
-----------------	----------------------	-----------	-------------------



- Log bars allow you to convert the cargo bed into a perfect transport space for 4' (120 cm) timber.
- The driver's safety is guaranteed by the protective front screen.

Hard Top	G2 (6x6 models only)	715002394	\$1,079.99
-----------------	----------------------	-----------	-------------------



- The hard top provides a 116 gal (440 L) cargo box.
- Locking secures your belongings.
- The cover raises assisted by gas cylinders.

Cargo Box Pool	G2L (6x6 models only)	715005256	\$379.99
	<ul style="list-style-type: none"> • Transforms the flatbed into a large capacity cargo box for increased loading possibilities. • Made of durable formed HDPE and shaped to maximize cargo space. • Allows access to vehicle's water-resistant rear compartment. • Designed for perfect fit and easy installation. 		
Tailgate Extension/ Divider	G2 (6x6 models only)	715002017	\$509.99
	<ul style="list-style-type: none"> • The sturdy tailgate extension provides a 10" (25 cm) extension to the cargo space. • Thanks to the longer cargo bed, even large loads pose no problem. • With the help of LinQ quick locks, the extension also acts as a solid space divider for the cargo bed. 		
Tarpaulin	G2 (6x6 models only)	715002416	\$399.99
	<ul style="list-style-type: none"> • Fitted to cover all of the items in your cargo box thoroughly. • Prevents splash from entering cargo box. • Easily removable for quick access. 		
18 Gal (70 L) Utility Box	G2 (6x6 models only)	715001999	\$559.99
	<ul style="list-style-type: none"> • Wherever you go and whatever you do, this handy 18 gal (70 L) utility box is your mobile storage. • The lid keeps your equipment safe from the elements in all conditions. • Sticks under the flatbed with handles for easy access. 		
Cargo Box Net	G2 (6x6 models only)	715001371	\$71.99
	<ul style="list-style-type: none"> • Solid net designed to hook to the bottom of the cargo box for secure and compact confinement of your cargo. 		
Soft Storage Bag	G2, G2L, G2S	715003759	\$179.99
	<ul style="list-style-type: none"> • 3-section bag. • Transport gear in a weatherproof bag. • 11.8 gal (45 L) capacity soft cargo bag designed with vehicle's rack in mind to maximize potential storage. • LinQ Luggage Rack (715001734) is required for G2S. 		
Storage 2.6 Gal (10 L) Bag		269502121	\$37.99
	<ul style="list-style-type: none"> • Roll-top dry bag for fully protecting your cargo from the elements. • Fits in rear compartment of your vehicle. 		



Deluxe Fairing	G2 (except X mr & 6x6), G2L	<ul style="list-style-type: none"> ■ 715001232 • Black ■ 715000935 • Yellow 2000 ■ 715002479 • Light Gray ■ 715006125 • Squadron Green ■ 715007073 • Tundra Green 	\$259.99



- Innovative, richly featured wind protection.
- Quick toolless removal: ovalance base brackets are mounted on handlebar.
- Two cup holders.
- Ready for GPS mounting kit.
- Optional mirrors and auxiliary lighting.
- Requires low, high or extra high windshield.
- Tapered Handlebar Adapter Kit is required for vehicles with 1" (28 mm) tapered aluminum handlebars.

Tapered Handlebar Adapter Kit <i>(Not illustrated)</i>	Deluxe Fairing	715002470	\$32.99
--	----------------	------------------	----------------

- Required to install Deluxe Fairing on an Outlander X-TP and on any vehicle equipped with 1" (28 mm) tapered aluminum handlebars.

Extra High Windshield	Deluxe Fairing	715000936	\$129.99
------------------------------	----------------	------------------	-----------------



- 16" (41 cm) windshield provides the ultimate protection against the elements while touring.
- Forward protection and winter applications.
- Toolless installation and replacement.

High Windshield	Deluxe Fairing	715001211	\$85.99
------------------------	----------------	------------------	----------------



- 11" (28 cm) high, forward protection and winter applications.
- Toolless installation and replacement.

Low Windshield	Deluxe Fairing	715001227	\$79.99
-----------------------	----------------	------------------	----------------



- 6" (15 cm) windshield allows you to keep your vehicle looking sporty while giving you some protection from the elements and the possibility of eyeing directional lighting.
- Toolless installation and replacement.

Accessories

Auxiliary Windshield Lighting	Deluxe Fairing	715003115	\$389.99
--------------------------------------	----------------	------------------	-----------------



- 2 premium LED spots for Deluxe Fairing for both increased output and directional lighting.
- 1,800 lumens.
- 2 x 10 W LED Cree light kit.
- Long-range illumination up to 350' (107 m), drawing less than 1 amp per light.

Deluxe Mirror Kit	Deluxe Fairing	715002353	\$71.99
--------------------------	----------------	------------------	----------------



- Improved mounting system.
- Wide rear view.
- Perfect fit with your Deluxe Fairing.

Windshield Kits

Extra High Windshield Kit G2,G2L,G2S (exceptX m rm odel s) **715003023** **\$299.99**



- Made of polycarbonate with integrated vent to reduce air turbulence and num ble noise at high speeds for a quieter and sm oother ride.
- Quick toolless rem ovalance base brackets are mounted on handlebar.
- Fits straight and tapered handlebars.
- Improved design for enhanced rigidity.
- Steering Cover (709400939) is required for XT and Mossy Oak models.
- 16" (41 cm) windshield.
- For ultimate wind protection and winter applications.

High Windshield Kit G2,G2L,G2S (exceptX m rm odel s) **715006382** **\$259.99**



- Made of polycarbonate with integrated vent to reduce air turbulence and num ble noise at high speeds for a quieter and sm oother ride.
- Quick toolless rem ovalance base brackets are mounted on handlebar.
- Fits straight and tapered handlebars.
- Improved design for enhanced rigidity.
- Steering Cover (709400939) is required for XT and Mossy Oak models.
- 11" (28 cm) windshield.
- For wind protection and winter applications.

Low Windshield Kit G2,G2L,G2S (exceptX m rm odel s) **715003021** **\$219.99**



- Made of polycarbonate with integrated vent to reduce air turbulence and num ble noise at high speeds for a quieter and sm oother ride.
- Quick toolless rem ovalance base brackets are mounted on handlebar.
- Fits straight and tapered handlebars.
- Improved design for enhanced rigidity.
- Steering Cover (709400939) is required for XT and Mossy Oak models.
- 6" (15 cm) windshield.
- Allows you to keep your vehicle looking sporty while giving you some protection from the elements.

HANDLEBARS & MIRRORS



Handlebar Wind Deflectors G2,G2L,G2S **\$32.99**



- Rugged injected plastic construction with Can-Am logo.
- Include rem oval cap for air flow adjustment.
- Mounting kit sold separately.

- **715000525** • Black / Yellow
- **715000537** • White / Black
- **715001706** • Black / Black
- **715003811** • Can-Am Red / Black
- **715003812** • Manta Green / Black
- **715003813** • Orange / Black
- **715003814** • Octane Blue / Black
- **715006117** • Squadron Green / Black
- **715006118** • Viper Red / Black

Passenger Wind Deflectors G2 and G2L (MAX models only) **715001669** **\$92.99**



- These wind deflectors fit on the passenger handles and provide greater comfort while riding.
- Easy to install and remove.

Full Wrap Aluminum Mounting Kit G2,G2L,G2S **715001378** **\$104.99**



- Lightweight black die cast aluminum construction.
- Includes complete hardware.
- Handlebar wind deflectors sold separately.

Aluminum Tapered Handlebar G2,G2L,G2S **715000550** **\$119.99**



- "-1" (22 mm -28 mm) tapered handlebar made of 6061-T6 aluminum.
- Includes all hardware, center steering foam and cover.

XT Handlebar Protector Kit	G2,G2L	703100352	\$92.99
-----------------------------------	--------	-----------	---------



- Not compatible with Mud Strap (715003053).

Mirrors Left " (10 mm)	G2,G2L,G2S	708200963	\$33.99
-------------------------------	------------	-----------	---------



- True vision surface 5"x3" (13 cm x 8 cm).
- Matte finish.
- Stem includes " (10 mm) thread.
- Bracket (715000190) is required for installation on DS 450.
- Bracket not required for installation on Outlander and Renegade.

Mirrors Right " (10 mm) (Not illustrated)	G2,G2L,G2S	709400523	\$33.99
---	------------	-----------	---------

- True vision surface 5"x3" (13 cm x 8 cm).
- Matte finish.
- Stem includes " (10 mm) thread.
- Bracket (715000190) required except for vehicles with right hand brake.

Handlebar Mirrors	G2,G2L,G2S	715005366	\$69.99
--------------------------	------------	-----------	---------



- Adjustable handlebar mounted convex mirrors.
- The convex surface allows improved visibility with a wider field of view.
- Doesn't require a windshield or fairing to be mounted.
- Works with all windshield options.

SEATS



Driver Backrest	G2L (except MAX models)	715003941	\$264.99
	G2 (except 6x6 & MAX models)	715003940	\$259.99
	G2 (6x6 models only, except MAX)	715003611	\$249.99



- Provides the riders back with that extra support that makes riding that extra mile way more comfortable.
- Adjusts horizontally to match the driver's height and preference.
- Mounts and locks firmly onto the vehicle.

Outlander Max Passenger Seat Kit	G2 2015 & up,G2L MAX models only)	715002373	\$699.99
---	-----------------------------------	-----------	----------



- Perfect to replace used or damaged passenger seat.

HMWPE SKID PLATES

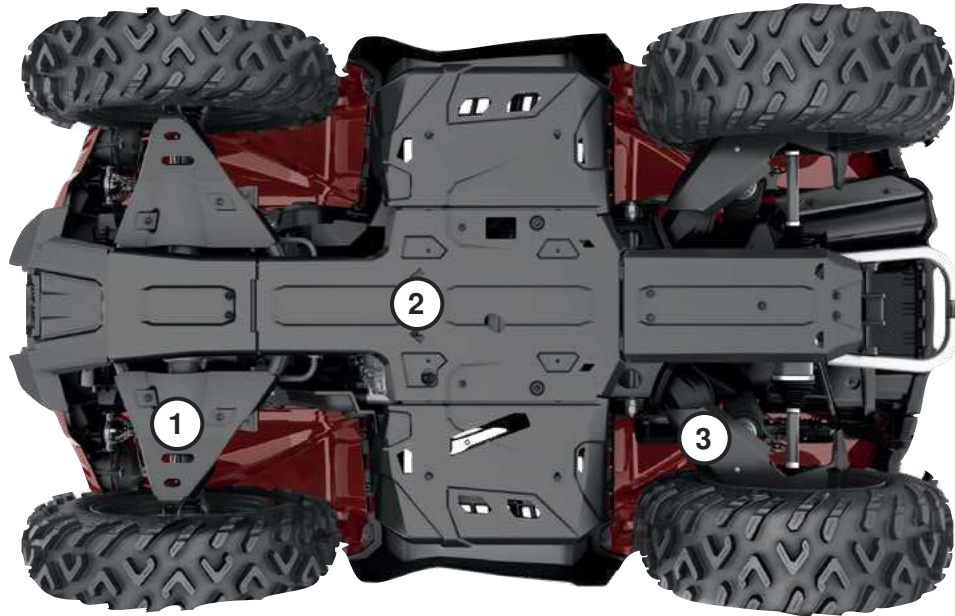

Our plastic plates glide smoothly and silently over obstacles, offering great protection in rough terrain. Made of 1/4" (6 mm) thick abrasion-resistant thermoformed High Molecular Weight Polyethylene (HMWPE).

- Lighter than aluminum.
- Superior stress crack resistance.
- High impact strength.

OUTLANDER RENEGADE

G2						G2L		G2S	
2016 & Prior		2017-2018		2019 & Up				2017-2018	2019-2022
Except MAX & Xmr 1000R models	MAX & Xmr 1000R models only	Except MAX & Xmr 1000R models	MAX & Xmr 1000R models only	Except MAX & Xmr 1000R models	MAX & Xmr 1000R models only	Except MAX models	MAX models only		

HMWPE Skid Plate Protection Kit

715004214	715004215	715004209	715004210	715004806	715004807	715004211	715004212	715004213	715004809
-----------	-----------	-----------	-----------	-----------	-----------	-----------	-----------	-----------	-----------

Individual HMWPE Skid Plates

① A-Arm Protectors	715002924	715002924	715002924	715002924	715004822	715004822	715002924	715002924	715002924	715004822
② Underbelly Plates <i>Footwell portion not compatible with Renegade Xmr</i>	715002926	715002927	715002926	715002927	715002926	715002927	715002928	715002929	715002974	715002974
③ Trailing Arm Protectors			715003466	715003466	715004823	715004823	715003466 (2015 to 2020 models only)	715003466 (2015 to 2020 models only)	715003466	715004823

ALUMINUM SKID PLATES



For ultimate durability and strength, all our Aluminum Skid Plates are made with $\frac{1}{8}$ " (4.5 mm) thick High Strength 5052 H32 Aluminum.

- Ultimate durability.
- High strength.

OUTLANDER

G2						G2L	
2016 & prior		2017-2018		2019 & up		Any year	
Except M AX & X m r1000R m odel s	M AX & X m r1000R m odel s on ly	Except M AX & X m r1000R m odel s	M AX & X m r1000R m odel s on ly	Except M AX & X m r1000R m odel s	M AX & X m r1000R m odel s on ly	Except M AX m odel s	M AX m odel s on ly

Aluminum Skid Plate Protection Kit

	715002137	715002138	715004197	715004198	715004804	715004805	715004199	715004200
--	-----------	-----------	-----------	-----------	-----------	-----------	-----------	-----------

Individual Aluminum Skid Plates

① A-Arm Protectors	715001667	715001667	715001667	715001667	715004820	715004820	715001667	715001667
② Front Skid Plate	715000926	715000926	715000926	715000926	715000926	715000926	715001906	715001906
③ Central Skid Plate	715002078	715002078	715002078	715002078	715002078	715002078	715002078	715002078
④ Footwell Protector Plates	715000922	715000922	715000922	715000922	715000922	715000922	715000922	715000922
⑤ Trailing Arm Protectors			715008595	715008595	715004821	715004821	715008595	715008595
⑥ Rear Differential Protectors	715000920	715000920	715000920	715000920	715000920	715000920	715000920	715000920
⑦ Rear Skid Plate	715002028	715002029	715002028	715002029	715002028	715002029	715002028	715002029

Aluminum Skid Plates



For ultimate durability and strength, all our Aluminum Skid Plates are made with 1/2" (4.5 mm) thick High Strength 5052 H32 Aluminum.

- Ultimate durability.
- High strength.

FENEGADE

G2S

	2016 & prior	2017-2018	2019-2022	2023 & up
Aluminum Skid Plate Protection Kit				
<i>Not compatible on Xmr models</i>	715002139	715004201	715004808	715009730
Individual Aluminum Skid Plates				
② A-Arm Protectors	715001667	715001667	715004820	715004820
② Front Skid Plate	715000925	715000925	715000925	715001906
③ Central Skid Plate	715002078	715002078	715002078	715002078
④ Footwell Protector Plates <i>Not compatible on Xmr models</i>	715001359	715001359	715001359	715001359
⑤ Trailing Arm Protectors	715001129	715008595	715004821	715004821
⑥ Rear Differential Protectors	715000920	715000920	715000920	715000920
⑦ Rear Skid Plate	715002028	715002028	715002028	715002028

HMWPE & ALUMINUM SKID PLATES

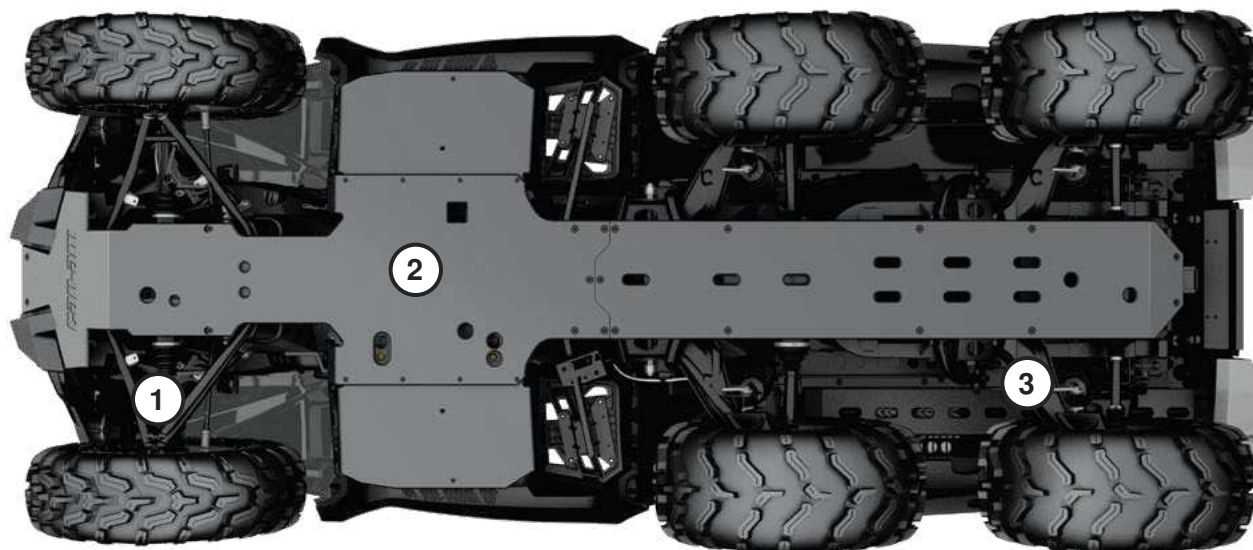

Our Plastic and Aluminum Plates glide smoothly and silently over obstacles, offering great protection in rough terrain.

HMWPE

Made of 1/4" (6 mm) thick abrasion resistant thermoplastic High Molecular Weight Polyethylene (HMWPE).

- Lighter than aluminum.
- Superior stress crack resistance.
- High impact strength.

ALUMINUM

Made with High Strength 1/4" (6.35 mm) thick 5052 H32 Aluminum.

- Ultimate durability.
- High strength.

OUTLANDER 6X6

	G2 6x6			G2L 6x6
	2016 & prior	2017 - 2018	2019 & up	Any year
Individual HMWPE Skid Plates				
① HMWPE A-Arm Protectors	715002924	715002924	715004822	715002924
② HDPE Full Underbelly Skid Plate	715005290 (except MAX)	715005290	715005290 (except MAX)	715005259 (MAX only)
	715005320 (MAX only)	715005320	715005320 (MAX only)	
③ HMWPE Trailing Arm Protectors		715003466	715004823	715003466 (2020 models & prior only)
Individual Aluminum Skid Plates				
① Aluminum A-Arm Protectors	715001667	715001667	715004820	715001667
② Aluminum Full Underbelly Skid Plate				
③ Aluminum Trailing Arm Protectors		715008595	715004821	715008595

BUMPERS & GUARDS



Bumpers

Expedition Front Bumper	G2, G2L (except X trim models & X xc models 2022 & up)	715007233	\$294.99
	<ul style="list-style-type: none"> • Made of 1.5" profiled steel tubes for complete protection of the vehicle's front. • Protects and does not obstruct the vehicle's headlights. • Integrated mounting spots for lights. • Inside and outside anti-rust coating with a durable powdercoat finish. 		
Expedition Rear Bumper	G2, G2L	715007234	\$269.99
	<ul style="list-style-type: none"> • Made of 1.5" profiled steel tubes for complete protection of the vehicle's rear. • Protects and does not obstruct the vehicle's taillights. • Inside and outside anti-rust coating with a durable powdercoat finish. • G2 base and DPS rear bumper installation requires 705008164 and 705008165. 		
X mr Front Bumper	G2S 2023 & up	715008198	\$289.99
	<ul style="list-style-type: none"> • Enhanced vehicle front protection. Required as a mounting point for Radiator Rebracket (715008898). 		
XT Front Bumper	G2	715004837	\$209.99
	<ul style="list-style-type: none"> • Provide additional protection against obstacles. • Tough and durable, can be added on base Outlander model to convert vehicle into XT model. • Standard on XT, XT-P, Mossy Oak and Limited models. • Large tube construction with textured black finish and metal corners. 		
XT Rear Bumper	G2	715004920	\$209.99
	<ul style="list-style-type: none"> • Provides additional protection against obstacles. • Tough and durable, can be added on base Outlander model to convert vehicle into XT model. • Standard on XT, XT-P, Mossy Oak and Limited models. • Large tube construction with textured black finish and metal corners. 		
XT Front Bumper	G2L	715001910	\$169.99
	<ul style="list-style-type: none"> • Winch compatible. • Large tube construction. • Protects vehicle against obstacles. • Standard on XT models. 		
XT Rear Bumper	G2L	715001911	\$134.99
	<ul style="list-style-type: none"> • Large tube construction. • Protects vehicle against obstacles. • Standard on XT models. 		

Extreme Front Bumper	G2	715001286*	\$309.99
	G2L	715004279	\$279.99



- Ultra-sturdy build.
- Enhances front-vehicle protection.
- Compatible with XT Front Bumper.
- Fits the Apache™ 360 Track System (when side panels are removed).

*Not compatible with Front Hitch.

Rancher Front Bumper	G2, G2L (except XM models)	715003461	\$339.99
-----------------------------	----------------------------	-----------	----------



- The low front-end protection and plates allow you to use your ATV within cattle herds and guard the safety of both the vehicle and the animals.
- The flat front portion facilitates gently prodding cattle or pushing light objects, e.g. closing a fence.
- The full frontage coverage extends to provide an extra layer of defense to your headlights and radiator.
- Inside and outside anti-corrosion coating with durable powdercoat finish.
- Not compatible with track systems, p/bws and front hitch.

Rancher Rear Bumper	G2, G2L (except 6x6 models)	715003462	\$289.99
----------------------------	-----------------------------	-----------	----------



- Ideal for using your ATV within cattle herds and guarding the safety of both the vehicle and the animals.
- Coverage extends to provide an extra layer of defense to your taillights.
- Inside and outside anti-corrosion coating with durable powdercoat finish.
- Not compatible with track systems.

Renegade Extreme Front Bumper	G2S 2022 and prior (except XM models)	715002469	\$269.99
--------------------------------------	---------------------------------------	-----------	----------



- Enhanced vehicle front protection.
- Required as a mounting point for Radiator Rebracket (715008898).

Guards

Body Side Protector	G2 2012 to 2018 with stock XT Bumper, G2 2012 & up with Rancher Bumper, G2L with Rancher Bumper (except XM and 6x6 models)	715003459	\$369.99
	G2 2019 & up with XT Bumpers (except XM and 6x6 models)	715004940*	\$379.99



- The heavy-duty fenderguard designed to pull double duty, protecting your ATV and also enhancing the look of your ATV.
- Made tough and designed to deliver a rugged appearance, this fenderguard offers full side protection for farm, ranch and forestry applications.
- Durable and built 1.25" (3 cm) diameter steel tube construction, with inside and outside anti-corrosion coating with durable powdercoat finish.
- Not compatible with Self-Clearing Footwell.
- XT Front and Rear Bumpers or Rancher Front and Rear Bumpers are required for installation.
- Requires Body Side Protector Extensions (715003460) for installation on MAX models.

*Not compatible with Front and Rear Rancher Bumpers.

Body Side Protector Extensions (Not illustrated)	G2, G2L (MAX models only)	715003460	\$72.99
--	---------------------------	-----------	---------

- This specially designed extension for the Body Side Protector is made specifically to fit and seamlessly integrate into the look of Outlander MAX models.

Mud Flaps	G2 (w/ stock fender flares)	715007089	\$58.99
------------------	-----------------------------	------------------	----------------



- Keeps mud, snow and debris out of cargo area and protects trailer and vehicles behind you.
- Adds aesthetic appearance to your vehicle.
- Requires stock fender flare.
- Sold in pairs.

Fender Flares	G2 2012-2018 (except w/ 30" tires) (except 6x6 models)	715001764*	\$159.99
	G2 2019 & up (w/ 30" tires) (except 6x6 models)	715004250**	
	G2L	715001909***	
	G2L European vehicles only 2015 & up	715004487	



- It's designed to deliver extra protection from dirt and debris, therefore a must if you enjoy riding in the mud.
- Made of injected plastic that hugs your vehicle fenders perfectly.
- Gives vehicle added flair for that rugged cool look.
- Includes front and rear extensions and all mounting hardware.

*Comes stock on G2 models 2019 & up (except Xmr models).

**Standard on G2 Xmr 1000R.

***Not compatible with European vehicles.

Fender Flare Extensions	G2 (except 6x6 models)	715005111*	\$249.99
--------------------------------	------------------------	-------------------	-----------------



- Block terrain debris from kicking up onto you as you ride or damage your vehicle thanks to these extra-large Fender Flare Extensions, which also include mud flaps for added protection from mud/snow, especially when riding with track kits.

• Made of High Molecular Weight Polyethylene (HMWPE) for advanced abrasion resistance.

• Include front and rear extensions.

*Must be used with Fender Flare for G2 (715001764).

Fender Flares	G2S (except Xmr models)	705012695	\$244.99
----------------------	-------------------------	------------------	-----------------



- Integrated extended Fender Flares for sporty look and full body protection from dirt and water.
- Include front and rear extensions and all mounting hardware.

Flatbed Protection Tubes	G2 (6x6 models only)	715002030	\$519.99
---------------------------------	----------------------	------------------	-----------------



- Bolt-on bumpers for the sides of the 6x6 flatbed.

• Protect the exterior plastic components of the flatbed from rocks, trees and other obstacles when traversing enclosed areas or loading cargo onto the bed.

Flatbed Protection Tubes	G2L (6x6 models only)	715005266	\$359.99
---------------------------------	-----------------------	------------------	-----------------



- Bolt-on bumpers for the sides of the 6x6 flatbed.

• Protect the exterior plastic components of the flatbed from rocks, trees and other obstacles when traversing enclosed areas or loading cargo onto the bed.



Integrated Heated Grips & Thumb Throttle Combo	G2, G2L, G2S (2024 & up)	715005072	\$299.99
---	--------------------------	------------------	-----------------



- Heat levels for grips and thumb displayed on vehicle screen.
- Ergonomic button integrated on LH grip.
- Single button for both grips and thumb heat selection.
- Five temperature settings for the thumb and grips.
- Adjustable heat ratio between grip and thumb warmer.
- Hold button to reach maximum heat quickly.
- Remembers your last heat setting.
- IP67-rated waterproof sealing keeps the elements out.
- ECE compliant.
- Plug-and-play installation.
- Clamp-on grips, no glue required.

Heated Grips & Thumb Throttle Combo	G2, G2L, G2S (except 2020 & up models equipped with 850 engine and 2019 & up models with 1000R engine, T-Category models)	715003250 Not compatible with Intelligent Throttle Control (ITC)	\$279.99
	G2, G2L, G2S (2020 & up models equipped with 850 engine and 2019 & up models with 1000R engine, T-Category models)	715008739 Compatible with Intelligent Throttle Control (ITC)	



- LED dimmer facilitates reading temperature settings.
- 4 temperature settings with individual controls for thumb and grips.
- Returns to previous heat setting.
- One-touch shutdown.
- Wiring Cable is required for installation on G2L models only.

Wiring Cable (Not illustrated)	G2L	710004567	\$11.99
--	-----	------------------	----------------

- Required for installation of Heated Hand Grips and Throttle Combo.

Heated Visor Outlet	G2, G2L	715001246	\$56.99
----------------------------	---------	------------------	----------------



- Strategically positioned on vehicle to maintain your agility.
- Optional visor outlet that delivers fog-free riding.
- Quick and easy installation.
- Sold individually.
- Heated Visor not included.

Heated Passenger Grips & Visor Outlet	G2, G2L (MAX models only)	715008794	\$239.99
--	---------------------------	------------------	-----------------



- Replace your stock passenger handles.
- Dual temperature switch integrated into seat arm for 3-zone heated handles and grips.
- Heated visor outlet integrated into seat arm.

USB Power Outlet Kit	G2, G2L, G2S	219400510	\$39.99
-----------------------------	--------------	------------------	----------------



- Recharges your electronic devices while riding* (sm artphone, MP3, heating gear, etc.).
- Dual port USB connectors.
- The power outlet is not capable of recharging all device types while riding.

Seat Heater	G2, G2L	715007211	\$134.99
--------------------	---------	------------------	-----------------



- 25 W seat heater delivers chill-free riding comfort.
- One temperature only.
- Heated pad and electrical harness only.
- Heavy Duty Seat Cover (715007212) is required for the installation.

Bluetooth Handlebar Soundbar by MTX	G2,G2L,G2S	219400840	\$489.99
--	------------	------------------	-----------------



- Bluetooth speaker with the unbeatable convenience of fingertip control.
 - Rugged IP66-rated weather-resistant speaker designed for outdoor use.
 - Driven by 150 watts of quality audio power.
 - Seamless integration and operation from Bluetooth enabled devices.
 - Includes input, ground and ignition wires, plus auxiliary port and 3.5" (Ø.89 cm) connector cable.
 - Not compatible with XT Handlebar Protector Kit.
 - EC compliant.
- Note: We recommend you use 320 Kbps MP3 - 192-256 Kbps AAC or AIFF, WAV formats to match the potential of the speaker. More compressed formats will probably have degraded sound quality.*

Electronic Device Holder	G2,G2L (except 6x6 & X m models)	715004919	\$144.99
---------------------------------	----------------------------------	------------------	-----------------



- Robust injected polypropylene construction allows for the right fit and easy installation.
- Adjustable unit safely holds smartphones or small tablets with a length or width measuring between 2.9" (7.5 cm) and 5.1" (13.0 cm) with or without protective case.
- Integrated storage (0.6 gal/2.1 L).
- Guiding wire grooves to pass charging cable through the lid.
- Possibility of relocating 12V power outlet or installing USB outlet in storage compartment (USB power outlet sold separately).
- Not compatible with windshield or Snorkel Kit.

3.5" (9 cm) LED Lights (2 X 14 W) LED Driving Lights	G2,G2L (except X m models)	715003666	\$254.99
---	----------------------------	------------------	-----------------



- 14 W LED lights producing 1,260 lumens each.
- Equipped with 6 high power LEDs in a heavy-duty die cast aluminum housing.
- Features 2 attachment points if one attachment point fails due to a collision, rotate to the next channel point and remount the light.
- Sold in pairs.
- EC compliant.
- Spot lens for a narrow and long light beam spread, ideal when driving at high speeds.
- Expedition FrontBumper (715007233) and LightPower Cable (715007275) required for installation.

3.5" (9 cm) LED Lights (2 X 14 W) LED Flood Lights	G2,G2L (except X m models)	715003665	\$254.99
---	----------------------------	------------------	-----------------



- 14 W LED lights producing 1,260 lumens each.
- Equipped with 6 high power LEDs in a heavy-duty die cast aluminum housing.
- Features 2 attachment points if one attachment point fails due to a collision, rotate to the next channel point and remount the light.
- Sold in pairs.
- EC compliant.
- Flood lens for a wide light beam spread, ideal for working applications like plowing or for cornering, dusty or foggy riding conditions.
- Expedition FrontBumper (715007233) and LightPower Cable (715007275) required for installation.

4" (10 cm) Round LED Lights (2 x 25 W)	G2,G2L (except X m models)	715002935	\$449.99
---	----------------------------	------------------	-----------------



- 25 W LED spotlights.
- 1,800 lumens.
- Rugged and waterproof.
- Includes basic wiring and switch.
- Can-Am branded grill.
- Sold in pairs.
- Not EC compliant.
- Expedition FrontBumper (715007233) and LightPower Cable (715007275) required for installation.

10" (25 cm) Double Stacked LED Light Bar (60 W)	G2,G2L (except X m models)	715002933	\$369.99
--	----------------------------	------------------	-----------------



- Equipped with twelve 5 W Cree LEDs.
- 5,400 lumens.
- Packs a big punch for its size.
- Rugged and waterproof.
- Can be installed on front bumpers, sport roof and bin in roof with sun visor.
- Requires light power cable for installation.
- Lights up to more than 1,500 ft (460 m) in front of the vehicle and around 65 ft (20 m) wide on each side.
- EC-compliant.

Light Power Cable (Not illustrated)	G2,G2L	715007275	\$119.99
---	--------	------------------	-----------------

- Required for installation of the 10" (25 cm) LED Light Bar, the 3.5" (Ø cm) and 4" (10 cm) LED Lights.

Baja Designs High Beam Kit	G2 (2022 and prior)	715004284	\$749.99
-----------------------------------	---------------------	------------------	-----------------



- Thanks to their direct bolt-on and plug-and-play installation right into the original high beam location, upgrading from your stock high beam lights to these powerful Baja Designs Squadron Pro LED Lights becomes child's play.
- Each spot is equipped with 4 Cree LEDs producing 4,900 lumens at 40 watts.
- Driving/Combo light pattern forms a smooth blend of light for both near field applications and distance.

2" (5 cm) Square LED Lights (2 X 10 W)	G2,G2L,G2S	715004293	\$204.99
---	------------	------------------	-----------------



- 2 x 900 lumens 10 W LED Cree light kit.
- Long-range illumination up to 350' (107 m), drawing less than 1 amp per light.
- Multi-Position Light Mount Kit is required for installation.
- Not EC compliant.

Multi Position Light Mount Kit	G2,G2L,G2S	715004274	\$96.99
---------------------------------------	------------	------------------	----------------



- Multi-position plastic clamp mounts that fit on various tubing sizes: 0.75" to 1.5" (19 mm to 38 mm).
- Required for the installation of the 2" (5 cm) Square LED Lights (2 x 10 W).
- Kit includes tube clamp mounts and power cables.

RAM[†] LED Spotlight	G2,G2L,G2S	710005423	\$18.49
--------------------------------------	------------	------------------	----------------



- 540-lumen LED light (Ø W) heavy-duty spotlight standard-equipped with 1" (2.5 cm) diameter rubber-coated double ball and socket system.

Battery Charger/ Maintainer		715005061	\$69.99
------------------------------------	--	------------------	----------------



- Keeps stored lead-acid batteries charged.
- Charges and maintains small batteries.
- Microprocessor controlled multi-stage charging for added precision, safety and battery life.
- Automatically detects 6- or 12-volt batteries.
- Reverse hook-up protection helps protect battery and charger from damage.
- Auto-voltage detection.
- Press the display button to show the charge progress.
- Content: 3 amp battery charger, clamp adapter, DC adapter, 24" (61 cm) fused ring leads harness with weathercap, owners manual.
- Not EC compliant.

Jump Starter		715005062	\$139.99
---------------------	--	------------------	-----------------



- IPX3 water-resistant and enclosed output ports.
- 4 LED battery indicators for easy read on battery charge level.
- Compact design, will conveniently fit in your backpack, glove box or any other storage compartment.
- 2.4A + 1A / 5V USB ports for fast charging of all USB devices.
- Ideal for power sports, motorcycles and 4 or 6 cylinder engines.
- Smart cable provides protection against reverse polarity, short circuit, low voltage, high temperature and reverse charging.
- Built-in LED light (3 modes).
- Content: 300CA jump starter, SA858 smart cable clamp, MC-USB to USB charging cable, travel bag, user manual.
- Not EC compliant.

Quick Connect Battery Cable		715005408	\$10.49
------------------------------------	--	------------------	----------------



- Quickly and easily connect and charge different items with your charger.
- Included in the Battery Charger/Maintainer (715005061).
- Sold individually.

Quick Connect Cable with Battery Indicator		715006055	\$22.49
---	--	------------------	----------------



- Quickly and easily connect and charge different batteries with your charger.
- 3-color LED indicator provides constant battery health indication.
- Sold individually.

GPS RAM[†] Mount for Handlebar	G2,G2L,G2S	715001985	\$68.99
--	------------	------------------	----------------



- Convenient bracket for installing the Garmin Mountana GPS (not included) onto your unit's handlebar.

Digitally Encoded Security System (D.E.S.S.[™]) Green Key	G2,G2S (2018 & up)	710005232	\$53.99
---	--------------------	------------------	----------------



- Anti-theft technology, Digitally Encoded Security System (D.E.S.S.) key snaps easily on the vehicle and provides riders easy and quick starts every time.
- The key communicates with the vehicle wirelessly so the vehicle starts only when the key code matches the vehicle, for ultimate peace of mind.
- The Programmable D.E.S.S. Key can also be programmed to 3 modes:
 - Work mode: Limits vehicle speed to 40 kph (25 mph) but does not limit engine torque.
 - Normal mode: Limits vehicle speed to 70 kph (44 mph) and 50% torque reduction.
 - Performance mode: No restrictions.



Can-Am HD Winches

Can-Am HD 2500 Winch	G2,G2L	715006414	\$309.99
-----------------------------	--------	------------------	-----------------



- Heavy-duty four-way roller fairlead.
- Ergonomic clutch handle.
- Rugged all-steel gears and bushings provide more torque and longer life.
- Automatic 100% load-holding brake.
- Sealed solenoid for all-weather protection.
- Wired Remote Control sold separately.
- Plug-and-play wiring and attachment brackets.
- Weathersealed handlebar-mounted switch.
- Pulling strength capability of 2,500 lb (1,134 kg).
- 50 ft. of 1/4" (6.35 mm) wire steel cable.
- EC-compliant.

Can-Am HD 3500 Winch	G2,G2L	715006415	\$349.99
-----------------------------	--------	------------------	-----------------



- Heavy-duty four-way roller fairlead.
- Ergonomic clutch handle.
- Rugged all-steel gears and bushings provide more torque and longer life.
- Automatic 100% load-holding brake.
- Sealed solenoid for all-weather protection.
- Wired Remote Control sold separately.
- Plug-and-play wiring and attachment brackets.
- Weathersealed handlebar-mounted switch.
- Pulling strength capability of 3,500 lb (1,588 kg).
- 50 ft. of 1/4" (6.35 mm) wire steel cable.
- EC-compliant.

WARN[†] VRX Winch

WARN VRX 35-S Winch	G2,G2L,G2S	715006109	\$669.99
----------------------------	------------	------------------	-----------------



- Extreme IP68-rated waterproof sealing keeps the elements out.
- Durable all-metal construction.
- Black powder-coated finish and stainless-steel fasteners for corrosion resistance.
- Robust new clutch design based on 70+ years of WARN 4WD hub lock know-how.
- Handlebar-mounted rocker control.
- Load-holding brake for great control.
- Smooth and reliable all-metal three-stage planetary gear train.
- Limited lifetime warranty (mechanical), 3-year warranty (electrical).
- Pulling strength capability of 3,500 lb (1,361 kg).
- 50 ft. of 1/4" (6.35 mm) synthetic rope.
- Cast aluminum fairlead.
- Wire Harness (715002453) required for installation.
- Winch mounting plate is required for G2S (STD and X xc 2022 and prior only).
- EC-compliant.

Winches Accessories

Wireless Remote Control	WARN Winches	715002542	\$214.99
--------------------------------	--------------	------------------	-----------------



- The system is quick and easy to install, thanks to a wiring harness with an integrated antenna and all necessary mounting hardware.
- The system allows you to operate your winch from anywhere within a 50' (15.2 m) radius, increasing your recovery options.
- All components are weatherproof.

Wired Remote Control	WARN Winches	715006378	\$89.99
	Can-Am HD Winches (715006414 & 715006415)	715006555	\$29.99
	Can-Am HD Winches (715008140 & 715008141)	715008121	\$30.99



- This kit allows winch owners to add the hand-held remote to their winch.
- This kit allows winch owners to add the hand-held remote to vehicles with a stock winch.
- Works in conjunction with the mini-rocker switch.
- Wired Remote and Remote Socket included.
- EC-compliant.

Winch Accessories Kit		715002409	\$124.99
------------------------------	--	------------------	-----------------



- Get the most out of your winch.
- Double your pulling power, change your pulling direction and keep your winch in proper working order.
- Includes tree straps, snatch block, shackle and winching gloves.

WARN Hawse Fairlead	WARN Winches	715007698	\$80.99
----------------------------	--------------	-----------	---------



- Double powder-coated construction.
- Required to use the Synthetic Winch.
- Cable (715004254) on WARN winches.
- To be used with synthetic winch cables only.

Roller Fairlead	WARN Winches	715007699	\$80.99
	Can-Am HD Winch	710007459	\$56.99



- Features top, bottom and side rollers for less cable wear and smoother operation from any direction for easier winching.

Hook with Safety Latch & Strap Kit (Not illustrated)	Can-Am HD Winches	705014949	\$23.49
--	-------------------	-----------	---------

- Heavy-duty winch-rope hook with stainless steel snap.
- Includes a nylon safety strap.

Replacement Wire Rope Can-Am HD	705014983	\$21.99
	705014984	\$35.99



- Play it safe, always carry a replacement wire rope.
- 2,500 lb (1,134 kg) pulling strength with 50 ft of 1/2" (15.2 m of 4.8 mm) wire rope for 705014983.
- 3,500 lb (1,588 kg) pulling strength with 50 ft of 5/8" (15.2 m of 5.5 mm) wire rope for 705014984.

Replacement Wire Rope ATV WARN Winches	715006256	\$75.99
---	-----------	---------



- Play it safe, always carry a replacement wire rope.
- 3,500 lb (1,588 kg) pulling strength.
- 50 ft. of 5/8" (15.2 m of 5.5 mm) aircraft grade steel wire.

Synthetic Winch Cable	ATV WARN Winches	715004254	\$154.99
------------------------------	------------------	-----------	----------



- Easier to manipulate than steel cable.
- Replaces the original cable on any factory installed WARN winch or sold as an accessory by BRP.
- Kit includes synthetic rope and rock guard sleeve.
- Always use with the new Hawse Fairlead (715007698).
- 50 ft. (15.2 m) of 1/2" (15.2 m of 4.8 mm) synthetic rope.
- 3,500 lb (1,588 kg) pulling strength.

Winch Mounting Plate	G2S 2022 & prior	715000927	\$129.99
-----------------------------	------------------	-----------	----------



- Adds functionality to your Renegade.
- Fits Can-Am winches by WARN.

Winch Wire Harness (Not illustrated)	G2 2021 & up, G2S 2021 & up and G2L	715002453	\$45.99
--	-------------------------------------	-----------	---------

- Required plug-and-go wiring to install WARN winch only.
- Not required for Can-Am HD winches.



Hitches

Rear Hitch	G2, G2L (except 6x6 models), G2S	715001925	\$58.99
-------------------	----------------------------------	------------------	----------------



- E-coat finish.
- Fixed hitch ball mounting bracket.
- Provides fixed mounting point for trailer ball to provide vehicle with towing capabilities.
- This hitch offers 1,300 lb (690 kg) of towing capacity.
- Hitch ball not included.

Front and Rear Hitch Drawbar	G2, G2L, G2S	715008350	\$99.99
-------------------------------------	--------------	------------------	----------------



- Standard on 2" (5 cm) receiver hitch.
- It offers 1,650 lb (750 kg) of towing capacity.
- Hitch ball not included.
- Forged steel.

Hitch Accessories

Rear Receiver Hitch	G2S 2012 w/ 800R or 1000 engines G2S 2013 & up, G2L & G2	715005186	\$119.99
----------------------------	--	------------------	-----------------



- E-coat finish.
- Does not affect ground clearance.
- Trailer ball not included.
- On 4x4 use, this hitch offers 1,500 lb (680 kg) of towing capacity.
- On 6x6 use, this hitch offers 1,654 lb (750 kg) of towing capacity.
- Compliant with European T regulations.
- Not compatible with G2L models with Rear Skid Plates.

Front Receiver Hitch	G2	715000921	\$104.99
-----------------------------	----	------------------	-----------------



- Front receiver hitch for Outlander without a winch.
- This hitch offers 1,300 lb (690 kg) of towing capacity.
- Allows you to maneuver your trailer easily in tight, confined areas.
- Hitch bars sold separately.
- Not compatible with Extreme Front Bumper, Rancher Bumper and Pro Mount P/Bws.

Rubber Receiver Plug		705204503	\$12.99
-----------------------------	--	------------------	----------------



- Rubber cap for 2" (5 cm) hitch receiver.

PERFORMANCE

Performance

Renegade Snorkel Kit	G2S (2020 & prior)	715006000	\$599.99
	G2S (2021 & up)	715007083	



- Comprehensive kit.
- Extended air intakes and CVT exhaust.
- CVT outlet integrates into pod cover.
- Ideal for muddy conditions.

Renegade Radiator Relocator Kit	G2S (2023 & up)	715008898	\$469.99
	G2S (2022 & prior)	715001929	



- Relocates radiator to top mount position.
- Prevents cooling performance loss in muddy conditions.
- Uses existing radiator.
- Includes support, hardware and hoses.
- Engineered for easy cooling system bleeding and maintenance.
- Radiator not included.
- Renegade Extreme Front Bumper (715002469) required for G2S 2022 and prior or X mr Front Bumper (715008198) required for 2023 and up for installation (except X mr).

Mud Strap	G2, G2L, G2S	715003053	\$47.99
------------------	--------------	------------------	----------------



- Convenient sturdy grab-handle.
- Lets drivers redistribute their weight for improved traction in demanding conditions.
- Not compatible with XT Handlebar Protector Kit (703100352).

Radiator Protector	G2, G2S (except G2S with 500 engine)	715001744	\$72.99
---------------------------	--------------------------------------	------------------	----------------



- Metal shield that mounts over radiator face, providing protection from stones and branches.

Outlander Snorkel Kit	G2 2015 & up, G2L (except X mr & 6x6 models)	715005999	\$469.99
------------------------------	--	------------------	-----------------



- Comprehensive kit.
- Extended air intakes and CVT exhaust.
- CVT outlet integrates into pod cover.
- Must be installed on a vehicle without XT Handlebar Protector Kit.
- Ideal for muddy conditions.
- Not compatible with windshields.

Outlander Snorkel Kit	G2 (X mr models only), G2L (X mr models only)	715002518	\$114.99
------------------------------	---	------------------	-----------------



- Comprehensive kit.
- Extended air intakes and CVT exhaust.
- CVT outlet integrates into pod cover.
- Must be installed on a vehicle without XT Handlebar Protector Kit.
- Ideal for muddy conditions.
- Not compatible with windshields.
- Raised horn only.
- Provides higher intake.
- For best fit and finish, appropriate gauge support is required.

Outlander Radiator Relocator Kit	G2, G2L (except X xc 2022 & up and 6x6 models)	715001930	\$469.99
---	--	------------------	-----------------



- Relocates radiator to top mount position.
- Prevents cooling performance loss in muddy conditions.
- Uses existing radiator.
- Includes support, hardware and hoses.
- Engineered for easy cooling system bleeding and maintenance.
- Radiator not included.

Xmr Traction Plates	G2 (MAX models only), G2L	715001752	\$124.99
----------------------------	---------------------------	------------------	-----------------



- Provide extra footgrip for driver when riding in extreme mud conditions.
- Help driver maintain ideal riding position to maximize vehicle traction.
- Made of aluminum.
- Not meant for a passenger.

Self-Clearing Footwells	G2 2015 & up, G2L	715004759	\$309.99
--------------------------------	-------------------	------------------	-----------------



- Made from aluminum.
- Replace original footwells.
- Feature large evacuation ports to avoid mud and snow accumulation in footwells.
- Aggressive design for improved traction.
- Not compatible with Body Side Protectors.
- Sold in pairs.

Footpeg Kit	G2, G2L	715001131	\$55.99
--------------------	---------	------------------	----------------



- Provides maximum integrated grip and more stability during vigorous riding.
- Kick-up end generates added grip during hard cornering.
- Made of aluminum.
- Sold in pairs.

Foam Air Filter by Twin Air†	G2, G2S, G2L	715001333	\$73.99
-------------------------------------	--------------	------------------	----------------



- Maximizes performance by increasing air flow throughout RPM range.
- Maintenance-friendly, i.e., just wash, re-oil and re-use after riding in severely dusty/muddy environments.

Heavy-Duty Springs

G2 2012-2018 (Base model, DPS, XT, Xmr with 650 engine only & Limited except 6x6)	715003199 •Front	\$149.99
G2S (Base model with 500 & 570 engines only)	715007203 •Front	\$124.99
G2L (except Mossy Oak, PRO, 6x6 and Xmr models)	715003200 •Rear	\$149.99
G2 2012-2018 (Base model, DPS, XT & Xmr with 650 engine only except 6x6)	715005159 •Front & Rear	\$264.99
G2S (Base model with 500 & 570 engines only)		
G2 2019 & up (Base, DPS & XT models, except 6x6)		



- Heavy-duty springs provide enhanced stiffness.
- Perfect for snow clearing and hauling heavy loads.
- Improve handling.
- Standard on Outlander PRO and Mossy Oak models.

Front Shock Covers	G2, G2L, G2S	715500301
---------------------------	--------------	------------------



- Feature ventilation holes.
- Offer added protection in rough terrain and weather conditions.
- Sold in pairs.

Yoshimura

Yoshimura Slip-On Exhaust Outlander	G2 (except 6x6 models)	715005480	\$699.99
---	------------------------	------------------	-----------------



- Made from 304-grade stainless steel.
- Better sounding, better looking and lighter than stock muffler.
- USDF/USDA approved spark arrester.
- Non-EPA compliant (for racing application only).
- Not EC compliant.
- Fuel injection system tuning not required.
- Not compatible with CARB and T Category models 2018 and up, NRM M and 650 Engine 2022 and up.

Yoshimura Slip-On Exhaust Renegade	G2S 2012 & up (except 570 engine and X m r models)	715005481	\$859.99
---	---	------------------	-----------------



- Made from 304-grade stainless steel.
- Better sounding, better looking and lighter than stock muffler.
- USDF/USDA approved spark arrester.
- Non-EPA compliant (for racing application only).
- Not EC compliant.
- Fuel injection system tuning not required.
- Not compatible with CARB and T Category models 2018 and up, NRM M and 650 Engine 2022 and up.

Emergency Accessories

Emergency Kit		715006102	\$159.99
----------------------	--	------------------	-----------------



- Complete emergency kit provides all essential equipment and supplies to get out of most unfavorable situations power sport enthusiasts may find themselves in.
- Includes jump cables, air compressor, tire repair kit, first aid kit, ratchet tie-down, duct tape, 3,300 lb (1,500 kg) tow strap, zip-ties and cloth rags.

COVERS, DECALS & ADD-ONS



Trailer Cover	G2 (except M AX models)	715001737	\$229.99
	G2 M AX and X m r 1000R models only)	715001736	\$279.99
	G2L (except M AX models)	715002026	\$229.99
	G2L M AX models only)	715002025	\$284.99
	G2S (except X m r models)	715000683	\$209.99



- Heavy-duty canvas made of UV-resistant solution-dyed polyester.
- Protect windshield and colored panels from abrasion.
- All high-abrasion areas are reinforced with a double canvas layer.
- Opening for fuel cap access.
- Weather-resistant trailer cover protects your vehicle during transportation.
- Quick and easy installation.
- Designed to perfectly fit your vehicle with or without Can-Am accessories.

Heavy-Duty Seat Cover	G2, G2L	715007212	\$55.99
------------------------------	---------	------------------	----------------



- Heavy-duty materials to cover and protect the seat.
- Abrasion- and tear-resistant.
- Simply installs by stretching around the original seat; the elastic holds the cover securely in place.

Storage Cover	G2, G2L, G2 X m r (except 1000), G2L X m r, G2S, G2S X m r	715001720	\$219.99
	G2, G2L (M AX and X m r 1000R models only)	715001668	\$224.99
	G2 (6x6 models only)	715002492	\$309.99
	G2, G2L (except M AX models)	715001597 • Mossy Oak Break-Up Country Camo	\$249.99



- Weather-resistant storage covers.
- For vehicle storage only.
- UV-resistant solution-dyed polyester construction.
- Quick and easy installation.
- Designed to perfectly fit your vehicle with or without Can-Am accessories.

Flag		715000277 • Yellow	\$32.99
-------------	--	---------------------------	----------------



- Make sure everyone knows what you're riding.
- Perfect for the dunes and new riders.
- 8-ft. (2.4 m) length.
- Includes Flag Mount (715000127).

Flag Mount (Not illustrated)	715000127	\$20.99
--	-----------	---------

Bolt-On[†] Retractable Ratcheting Tie-Downs	295100737	\$30.99
---	-----------	---------



- Perfect for transporting your power sport vehicle or securing loads.
- Mounts easily: Bolts on any flat surface (e.g., truck bed or frame).
- 1" x 6' (2.5 cm x 1.8 m) tie-down strap with heavy-duty stitching that delivers a 500 lb (226 kg) working load strength and 1,500 lb (680 kg) break strength.
- Convenient retractable push button automatically slackens, spools and stores away strap, while the ratchet mechanism tightens the strap snugly to secure your vehicle or load into place.
- Rubber ratcheting handle provides firm grip, and the hook is vinyl coated to protect whatever surface it hooks into.
- Sold in pairs.

Ratchet Tie-Downs	715008309 • Black/Grey	\$24.49
--------------------------	------------------------	---------



- 400 lb (181 kg) safe working load.
- 1" x 10' (2.5 cm x 3 m) strap with Can-Am, Sea-Do, and Ski-Doo logos.
- Deluxe ratchet with rubber handle.
- Coated S hooks.
- Pack of 2.

Heavy-Duty Ratchet Tie-Down	715008308	\$44.99
------------------------------------	-----------	---------



- 1,000 lb (454 kg) safe working load.
- 1.5" x 6' (38 mm x 1.8 m) strap with BRP brands.
- Deluxe ratchet with rubber handle.
- Black-coated clip hooks.
- 12 (300 mm) webbing included.
- Pack of two.

Shifter Lock	G2, G2L	715007337
---------------------	---------	-----------



- Secure the vehicle's shifter by locking it in position.
- Prevents the vehicle from going into neutral without the lock key.

Lockable Gas Tank Cap	G2, G2L, G2S	860200387	\$48.99
------------------------------	--------------	-----------	---------



- Protects your fuel.
- Meets EPA requirements.

License Plate Bracket	G2L	715002498	\$24.49
	G2S	715001401	\$23.99



- Provides specific area to install license plate.
- Mounts to rear of vehicle.



Apache Track Systems

Apache Backcountry Track System

G2 (except 6x6 models), G2L, G2S

715005247



- Designed to deliver the best flotation level and deep-snow performance on the market.
- Contact patch is 23% bigger than the Apache 360 LT.
- Ingressive added ground clearance of 7" (18 cm), keeps the vehicle out of deep snow.
- Aggressive track design with 2" (5 cm) lug height for maximum traction on snow.
- Apache Backcountry Mounting Kit and engine and air intake pre-filters are required.
- For winter use only.

Idler Wheel Kit

Apache Backcountry Track System
(rear tracks only)

860201230
• 141 mm



- Reduces drag and rolling resistance.
- Includes 2 wheels, brackets and hardware.
- Add up to 2 kits per rear track.
- Can extend idler life in hardened snow conditions.

Sliders with Vespel® Inserts

Apache Backcountry Track System

503194815



- Use DuPont Vespel inserts for less friction.
- Longer life.
- Can be cut to desired length.
- 8 needed per vehicle.
- Sold individually.

Rail Ice Scratchers

Apache Backcountry Track System

860201728



- Provide additional lubrication in hard and icy conditions.
- Rail mounted, small, light.
- Design expands on coil concept to allow reversing without damage.
- Easily stored when not in use.

Apache 360 & 360 LT

Apache 360 Track System

G2 (except 6x6 models), G2L, G2S

715006323



- Multifunctional tracks perfect for any Can-Am ATV.
- Average ground clearance of 16" (41 cm).
- 1" (2.5 cm) lugs in the front and 1.25" (3.2 cm) in the back.
- Apache 360 and 360 LT Mounting Kit and engine and air intake pre-filters are required.

Apache 360 LT Track System

G2, G2L, G2S

715005103



- Multifunctional tracks designed to support heavy loads and to fit on most Can-Am Off-Road vehicles.
- Extra contact patch adjustment for better performance over rough terrain.
- Contact patch is 7 to 9% bigger than the Apache 360s. Average ground clearance of 16" (41 cm), 1" (2.5 cm) lugs in the front and 1.25" (3.2 cm) in the back.
- EC compliant.
- ATV: Apache 360 and 360 LT Mounting Kit, Track DPS Module and Engine and CVT air intake pre-filters are required and sold separately.

Apache 360 LT 6x6

Apache 360 LT (6x6) Track System

G2, G2L (6x6 only)

715005104



- Multifunctional tracks designed to support heavy loads and to fit on most Can-Am OffRoad vehicles.
- Front wheel height adjustment provides enhanced attack angle and better performance over rough terrain when raised or increased contact patch for improved flotation when lowered.
- Average ground clearance increase of 4.5" (11.4 cm).
- 1" (2.5 cm) lugs in the front and 1.25" (3.2 cm) in the back.
- Apache 360 LT Mounting Kit, Track DPS Module and Engine and Pre-Filter Kit are required.
- Reliable heavy-duty build.
- Economical.
- Exclusively for the Outlander 6x6.
- Recommended for use on snow only.

Apache Accessories

Apache Backcountry Mounting Kit

(Not illustrated)

G2 2018 & prior, G2S 2018 & prior, G2L

715004830

G2 2019, G2S 2019

715004796

- Required for installation of the Apache Backcountry Track System.
- DPS module and pre-filter are required and sold separately.

Track DPS Module

(Not illustrated)

G2, G2L, G2S

715007338

- An innovative DPS module that ensures speedometer accuracy and optimized steering assist, which make for perfect track control and riding ease.
- Required to install the Apache and Backcountry Track Systems.

Apache 360 & 360 LT Mounting Kit

(Not illustrated)

G2 2018 & prior (except 6x6 models), G2S 2018 & prior, G2L

715007207

G2 2019 & up (except 6x6 models), G2S 2019 & up

715007206

G2 2018 & prior, G2L (6x6 models)

715004991

G2 (6x6 models 2019 & up)

715005105

- Required to install Apache 360 and 360 LT Track Systems.
- DPS module and pre-filter not included.

Apache Track System Accessories

Air Intake Pre-Filter

715003483



- Adds extra protection to your engine in harsh riding conditions.
- Filter blocks particles larger than 0.007" (0.19 mm).
- Easy, toolless installation.
- Necessary to maintain vehicle warranty when tracks are installed.
- Required to install the Apache and Backcountry Track Systems.
- Standard on Outlander 650, 650 X-M, 850, 1000, 1000R engines and G2L PRO.
- Not compatible with Snorkel Kits.

Engine Air Intake Pre-Filter

G2, G2L, G2S

715004729



- Adds extra protection to your engine in harsh riding conditions.
- Filter blocks particles larger than 0.005" (0.13 mm).
- Necessary to maintain vehicle warranty when tracks are installed.

APACHE TRACK SYSTEMS FITTING GUIDE

Apache Backcountry

Model Year / Model	Track	Track Mount	Track DPS Module	Prefilter without Snorkel	Prefilter with Snorkel
2015 & Up G2L	715005247	715004830	715007338	715004729 & 715003483 (standard on G2 models and G2L PRO model)	715004729
2018 & Prior G2,G2S					
2019 & Up G2,G2S		715004796			

Apache 360 and Apache 360 LT

Model Year / Model	Track	Track Mount	Track DPS Module	Prefilter without Snorkel	Prefilter with Snorkel
2015 & Up G2L	715006323 (Apache 360) OR 715005103 (Apache 360 LT)	715007207	715007338	715004729 & 715003483 (standard on G2 models and G2L PRO model)	715004729
2018 & Prior G2,G2S					
2019 & Up G2,G2S		715007206			

Apache 360 LT 6x6

Model Year / Model	Track	Track Mount	Track DPS Module	Prefilter without Snorkel	Prefilter with Snorkel
2018 & Prior G2 6x6	715005104	715004991	715007338	715004729 & 715003483 (standard on G2 models and G2L PRO model)	715004729
2019 & Up G2L 6x6					
2019 & Up G2 6x6		715005105			

PROMOUNT FLOWS



PROMOUNT FLOW KITS

Reference Chart

	54" Black Steel	54" Yellow Steel	60" Black Steel	60" Yellow Steel	66" Black Steel	66" Yellow Steel	60" Flex2
Push Kit	715007753	715008178	715007754	715008179	715007755	715008180	715008181
Blade	715004472	715005316	715004202	715005317	715006337	715006338	715004203
Push Frame	715007752	715007752	715007752	715007752	715007752	715007752	715007752
Mounting Plate	715007751	715007751	715007751	715007751	715007751	715007751	715007751

Steel Plows

Can-Am ProMount Steel Plow Kits 54" (137 cm) Blade

G2,G2L,G2S

■ 715007753 •Black
■ 715008178 •Yellow

\$989.97



- These kits include:
 - Can-Am ProMount Steel Blade
 - Push Frame with Quick-Attach System
 - Mounting Plate

Can-Am ProMount Steel Plow Kits 60" (152 cm) Blade

G2,G2L,G2S

■ 715007754 •Black
■ 715008179 •Yellow

\$1,019.97



- These kits include:
 - Can-Am ProMount Steel Blade
 - Push Frame with Quick-Attach System
 - Mounting Plate

Can-Am ProMount Steel Plow Kits 66" (168 cm) Blade

G2,G2L,G2S

■ 715007755 •Black
■ 715008180 •Yellow

\$1,069.97



- These kits include:
 - Can-Am ProMount Steel Blade
 - Push Frame with Quick-Attach System
 - Mounting Plate

Can-Am ProMount Steel Blades 54" (137 cm) Blade

Fits ProMount Push Frame

■ 715004472 •Black
■ 715005316 •Yellow

\$329.99



- Blades available individually to create your own kit.
- Compatible with Can-Am ProMount Blade accessories to further enhance plow versatility (some plow accessories are not compatible with 54" (137 cm) plows).
- Not compatible with ProMount Diff Cutters, Blade Extensions and Edge Markers.
- Clears 50" (127 cm) when plow is fully angled.
- Blade height of 14.75" (37 cm).

Can-Am ProMount Steel Blades 60" (152 cm) Blade

Fits ProMount Push Frame

■ 715004202 •Black
■ 715005317 •Yellow

\$359.99



- Blades available individually to create your own kit.
- Compatible with Can-Am ProMount Blade accessories to further enhance plow versatility.
- Clears 54" (137 cm) when plow is fully angled.
- Blade height of 17" (43 cm).

Can-Am ProMount Steel Blades 66" (168 cm) Blade

Fits ProMount Push Frame

■ 715006337 •Black
■ 715006338 •Yellow

\$409.99



- Blades available individually to create your own kit.
- Compatible with Can-Am ProMount Blade accessories to further enhance plow versatility.
- Clears 60" (152 cm) when plow is fully angled.
- Blade height of 17" (43 cm).

Can-Am ProMount Steel Blades 72" (183 cm) Blade

Fits ProMount Push Frame

■ 715004474 •Black
■ 715006021 •Yellow

\$479.99



- Blades available individually to create your own kit.
- Compatible with Can-Am ProMount Blade accessories to further enhance plow versatility.
- Clears 66" (168 cm) when plow is fully angled.
- Blade height of 17" (43 cm).

Can-Am ProMount Flex2 Plow Kit

Can-Am ProMount Flex2 60" (152 cm) Plow Kit	G2,G2L,G2S	715008181	\$1,099.97
--	------------	-----------	------------



- These kits include:
 - Can-Am ProMount Flex2 Blade
 - Push Frame with Quick-Attach System
 - Mounting Plate

NEW Can-Am ProMount Flex2 66" (168 cm) Plow Kit	G2,G2L,G2S	■ 715008182 •Black	\$1,169.97
--	------------	--------------------	------------



- This kit includes:
 - Can-Am ProMount Flex2 Blade
 - Push Frame with Quick-Attach System
 - Mounting Plate

Angle Plows

Can-Am ProMount Angle Blades 60" (152 cm) Steel Oneway State Blade	G2,G2L,G2S	715007261	\$419.99
---	------------	-----------	----------



- Make the job easier with the right tools, clearing alleys and make the task easier by sending the snow further out of the way.
- Wing end of plow measures 25" (63 cm) high and tapers down to 17" (43 cm).
- One-way winged state plow designed to throw snow higher.
- Rubber Flap (715007299) designed to keep snow away from the driver is offered as accessory (sold separately).
- Can-Am branded.

Can-Am ProMount Angle Blades 66" (168 cm) Steel Oneway State Blade	G2,G2L,G2S	715007263	\$489.99
---	------------	-----------	----------



- Make the job easier with the right tools, clearing alleys and make the task easier by sending the snow further out of the way.
- Wing end of plow measures 25" (63 cm) high and tapers down to 17" (43 cm).
- One-way winged state plow designed to throw snow higher.
- Rubber Flap (715007299) designed to keep snow away from the driver is offered as accessory (sold separately).
- Can-Am branded.

Can-Am ProMount Angle Blades 72" (183 cm) Steel Oneway State Blade	G2,G2L,G2S	715007264	\$539.99
---	------------	-----------	----------



- Make the job easier with the right tools, clearing alleys and make the task easier by sending the snow further out of the way.
- Wing end of plow measures 26" (67 cm) high and tapers down to 17" (43 cm).
- One-way winged state plow designed to throw snow higher.
- Rubber Flap (715007299) designed to keep snow away from the driver is offered as accessory (sold separately).
- Can-Am branded.

ProMount One-Way State Blade Rubber Flap (Not illustrated)		715007299	\$119.99
--	--	-----------	----------

- Allows for more efficient snow projections in various snow conditions.

Can-Am ProMount Flex2 Plows

Can-Am ProMount Flex2 60" (152 cm) Blade	Fits ProMount Push Frame	715004203	\$439.99
---	--------------------------	------------------	-----------------



- Plow blade made of UHMWPE, flexible and in fact absorbing material prevents damaging your plow when accidental impacts occur.
- Replaceable wear blade.
- Large pin designed for easy blade rotation to eliminate snow buildup at pivot point.

- Blade design provides best snow rolloff at any angle.
- Compatible with Can-Am ProMount Blade accessories to further enhance plow versatility.
- Clears 54" (137 cm) when plow is fully angled.
- Blade height of 17" (43 cm).

Can-Am ProMount Flex2 66" (168 cm) Blade	Fits ProMount Push Frame	715006265	\$509.99
---	--------------------------	------------------	-----------------



- Plow blade made of UHMWPE, flexible and in fact absorbing material prevents damaging your plow when accidental impacts occur.
- Replaceable wear blade.
- Large pin designed for easy blade rotation to eliminate snow buildup at pivot point.

- Blade design provides best snow rolloff at any angle.
- Clears 60" (152 cm) when plow is fully angled.
- Blade height of 17" (43 cm).
- Compatible with Can-Am ProMount Blade accessories to further enhance plow versatility.

Can-Am ProMount Flex2 72" (183 cm) Blade	Fits ProMount Push Frame	715004485	\$589.99
---	--------------------------	------------------	-----------------



- Plow blade made of UHMWPE, flexible and in fact absorbing material prevents damaging your plow when accidental impacts occur.
- Replaceable wear blade.
- Large pin designed for easy blade rotation to eliminate snow buildup at pivot point.

- Blade design provides best snow rolloff at any angle.
- Compatible with Can-Am ProMount Blade accessories to further enhance plow versatility.
- Clears 66" (168 cm) when plow is fully angled.

Can-Am ProMount Plow Accessories

Can-Am ProMount Push Frame with Quick-Attach System	G2, G2L, G2S	715007752	\$499.99
--	--------------	------------------	-----------------



- Heavy-duty steel tubes designed to withstand the roughest use.
- Mounting carriage provides ultimate push strength and traction.
- Designed for maximum plow lift height.
- Features a self-aligning quick-attach system, an easy foot release pedal and an ergonomic handle for plow angle adjustment.

- Plow Roller Fairlead and Plow Linch Hitch recommended to extend winch cable lifespan.
- Can-Am ProMount Mounting Plate required for installation.
- Blade swivels left or right, 5 positions.
- Large pin designed for easy blade rotation to eliminate dirt and snow buildup at pivot point.

Can-Am ProMount Mounting Plate	G2, G2L, G2S	715007751	\$159.99
---------------------------------------	--------------	------------------	-----------------



- Required to install the Can-Am ProMount Push Frame with Quick-Attach System.
- Mounting plate precision-designed to stay on year round without compromising ground clearance.
- Fits on ATVs with or without Can-Am Ski Plates.
- Plow Roller Fairlead included.

Can-Am ProMount Push Frame Extension	G2, G2L, G2S	715006257	\$174.99
---	--------------	------------------	-----------------



- 12" (30 cm) push frame extension.
- Required when plow is installed with Apache Track System.

Can-Am ProMount Edge Markers	G2, G2L, G2S	715004206	\$45.99
-------------------------------------	--------------	------------------	----------------



- Help locate the edges of your plow.
- Height: 24" (60 cm).
- Sold in pairs.
- Compatible with Can-Am ProMount Steel and Flex2 Blades with or without Blade Extensions (except for the Can-Am ProMount Steel 54" (137 cm) Blades).

Can-Am ProMount Drift Cutters	G2,G2L,G2S	715006258	\$159.99
--------------------------------------	------------	------------------	-----------------



- Help keep snow in the plow.
- Dimensions: 17" x 13" (43.2 cm x 33 cm).
- Sold in pairs.
- Compatible with Can-Am ProMount Steel and Flex2 Blades with or without Blade Extensions (except for the Can-Am ProMount Steel 154" (137 cm) Blades).

Can-Am ProMount Curved Wear Blade	G2,G2L,G2S	715007791 • 60" (152 cm) 715007792 • 66" (168 cm)	\$114.99
--	------------	--	-----------------



- Wear blade designed with a folded back bottom lip.
- The increased surface allows for less digging while plowing uneven surfaces.
- Ideal for snow covered gravel, grass, paverstone and other soft surfaces.

Can-Am ProMount Plastic Wear Blade	G2,G2L,G2S	715004480 • 54" (137 cm)	\$139.99
		715004481 • 60" (152 cm)	\$159.99
		715004482 • 66" (168 cm)	\$179.99
		715004483 • 72" (183 cm)	\$199.99



- To help prevent scratches on smooth driveways and markable surfaces.

Can-Am ProMount Blade Extensions	G2,G2L,G2S	■ 715004205 • Black ■ 715005319 • Yellow	\$119.99
---	------------	---	-----------------



- Add 3" (8 cm) each side.
- Compatible with Can-Am ProMount Blades (except for Can-Am ProMount Steel 154" (137 cm) Blade).
- Longer Wear Blade can be installed to further extend the extra length already provided by the extensions.
- Compatible with Can-Am ProMount Steel and Flex2 Blades (except for the Can-Am ProMount Steel 154" (137 cm) Blades).

Back Drag Blade	ProMount Plows (60" and more)	715007794	\$279.99
------------------------	-------------------------------	------------------	-----------------



- Thick steel wheels scraper.
- Lifts up when the vehicle is moving forward so as to not affect the scraping.
- Increased capacity to pull snow.
- More aggressive scraping in reverse mode.
- Lifts the blade off the ground so that it scrapes evenly.
- Adjustable in length for compatibility with 60", 66" and 72" blades.
- Compatible with ProMount blades (Flex and Steel).

Plow Roller Fairlead	G2,G2L,G2S	705009222	\$69.99
-----------------------------	------------	------------------	----------------



- Larger diameter roller reduces wear on wire rope for plow application.
- Can be used with all ProMount plows.
- Included in Plow Mounting Plate Kit (715007751).

Pulley Kit for Alpine Super-Duty Plow	G2,G2L	715000279	\$57.99
--	--------	------------------	----------------



- Pulley kit to be used in conjunction with the winch when using a snow plow.
- Recommended to increase winch efficiency.
- To be used with the XT Front Bumper.

Synthetic Winch Cable for Plowing

715000540

\$46.99



- Specially designed for plowing applications.
- 8' (2.4 m) section of durable, extra-strong synthetic rope.
- Stands up to repeated, sharp angle pulls used to lift heavy plow blades.
- Temporarily replace your winch rope for plow season to save wear and tear on wire rope.

Plow Limit Switch *(Not illustrated)*

G2, G2L, G2S

715006259

\$134.99

- For controlling the cable tension when over-raising your plow system.
- Prevents winch, plow push frame and vehicle damage.

Can-Am ProMount Plow Angling System

G2, G2L, G2S

715007801

\$799.99



- Converts your plow system into an easy-to-control unit from the driver's seat.
- Using one hand to control all plow motions will allow you to easily concentrate and manage your plowing tasks.
- Compatible with ProMount Blade.
- Push Frame (715007752) is required.
- Push Frame Extension (715006257) is required for installation with the Front Rancher bumper.
- Winch and plow sold separately.





G3L ACCESSORIES

G3L ACCESSORIES

G3L ACCESSORIES

LinQ Accessories: Easy On, Easy Off Cargo	84
Cargo & Storage	90
Can-Am Windshields	90
Handlebars & Mirrors	91
Skid Plates	92
Bumpers & Guards	93
Electrical & Lights	94
Winches	97
Hitches	98
Performance	99
Covers & Add-Ons	100
Apache Track Systems	101
ProMount P lows	103



BUNDLE UP TO NEVER COMPROMISE YOUR ATV BUNDLES

STEP 1: CHOOSE YOUR ESSENTIAL BUNDLE

		G3L	G3L MAX
STARTER	Console Extension	715005368	715005368
	Console Extension USB Power Outlet	715008750	715008750
	LinQ Cargo Box (53 L)	715006997	715006997
	LinQ ToolKit	715006829	715006829
ADVANCED	Fender Flares	715005349	715005349
	Driver Full Wrap Handguards	715005361	715005361
	LinQ Modular Box (10 L)	715005494	715005494
PEAK	Bluetooth Handlebar Soundbar by M TX	219400840	219400840
	Adventure High Windshield	715005377	715005377
	Mud and Dust Wash	9779340	9779340
	Multi-Surface Glass Cleaner	9779331	9779331
	Black Plastic & Rubber Restorer	9779335	9779335

STEP 2: PICK YOUR ADD-ON BUNDLE

		G3L	G3L MAX
ADVENTURE	LinQ Stackable Fuel Caddy - 4 Gallons	860202246	860202246
	XT Rear Bumper	715004953	715004953
	XT Front Bumper	715004952	715004952
HUNT	3.5" (9 cm) LED Driving Lights (2 x 14 W)	715003666	715003666
	LinQ Gun Case	715004968	715004968
	XU Front Bumper	715006614	715006614
	LinQ Gear Grips	715005340	715005340
WORK	LinQ Chainsaw Holder	715004975	715004975
	LinQ Rack Extension	715004954	715004954
	LinQ Tool Holder	715007358	715007358
WINTER	Integrated Heated Grips & Thumb Throttle Combo	715005072	715005072
	Adventure Side Wind Deflectors	715005862	715005862
	Heated Visor Outlet	715001246	715001246
	Heated Passenger Grips & Visor Outlet	N/A	715005358
	Trailer Cover	715005074	715005075













LINQ ACCESSORIES EASY ON, EASY OFF CARGO









- No tools needed: Quickly install and remove accessories by hand.
- Equip your Can-Am vehicle for specialized tasks in no time.
- Sturdy mounting system that holds up to the roughest terrain.

G3L



LinQ Accessories with 16" Base

	① Front Cargo Compartment	② Front Rack	③ Rear Cargo Compartment	④ Rear Rack	LinQ Can Stack on Top			
 LinQ 4.2 Gal (16 L) Cooler 219400964 • Black / 295100698 • White	YES, with LinQ Base Installation Kit 860201806	NO	YES, with LinQ Base Installation Kit 860201806	NO	NO			
 LinQ Tool Box 715008111	Can be installed inside* on the front cargo compartment.							
 LinQ SR 5.5 Gal (21 L) Bag 860202449	YES, with LinQ Base Installation Kit 860201806 Must be installed on the front cargo compartment lid only.							
 LinQ 4.5 Gal (17 L) Sport Bag 860202447	YES, with LinQ Base Installation Kit 860201806 Can be installed inside* on the front cargo compartment.							
 LinQ Modular Box (10 L) 715005494								
 LinQ Modular Box (20 L) 715007112	NO					NO	YES	
 LinQ Modular Box (30 L) 715006830							NO	
 LinQ Tool Kit 715006829							YES	
 LinQ Roll-Top Bag 715008110	YES, with LinQ Base Installation Kit 860201806 Must be installed on the front cargo compartment lid only.					NO	NO	NO
 LinQ Fuel Caddy - 4 Gallons 860202246	YES, with LinQ Base Installation Kit 860201806							
 LinQ Oil Caddy - 1 Gallon 860202445	Must be installed inside* the front cargo compartment only.							
 LinQ Gun Case 715004968	YES, with LinQ Base Installation Kit 860201806 Must be installed on the front cargo compartment lid.							

LinQ Accessories with 36" Base

	Front Cargo Compartment	Front Rack	Rear Cargo Compartment	Rear Rack	LinQ Can Stack on Top	
 LinQ Large Cargo Box 715007001	NO	NO	NO	YES	NO	
 LinQ Cargo Basket (90 L) 715005274		YES			YES	YES
 LinQ Cargo Box (53 L) 715006997			YES	YES	YES	
LinQ Low Profile Box (63 L) 715007827		NO	NO	YES, remove the rear rack for installation.	NO	
 LinQ Trunk Box (139 L) 715006097					NO	YES
 LinQ Trunk Box (145 L) 715005273					NO	NO
LinQ 9.2 Gal (35 L) Cooler 715006998		YES	YES	NO	YES	NO
 LinQ Gun Case 715004968					NO	

LinQ Holders and Racks

	Front Cargo Compartment	Front Rack	Rear Cargo Compartment	Rear Rack	LinQ Can Stack on Top
 LinQ Gear Grips 715005340	YES, with LinQ Base Installation Kit 860201806	YES	YES, with LinQ Base Installation Kit 860201806	YES	NO
LinQ Tool Holder 715007358					
 LinQ Rack Extension 715004954	NO	NO	NO	NO	NO
 LinQ Chainsaw Holder 715004975	YES				

*Removal of front cargo compartment lid is required.

LINQ ACCESSORIES EASY ON, EASY OFF CARGO



- No tools needed: Quickly install and remove accessories by hand.
- Equip your Can-Am vehicle for specialized tasks in no time.
- Sturdy mounting system that holds up to the roughest terrain.

G3L MAX

LinQ Accessories with 16" Base	① Front Cargo Compartment	② Front Rack	③ Rear Cargo Compartment	④ Rear Rack	LinQ Can Stack on Top			
LinQ 4.2 Gal (16 L) Cooler 219400964 • Black / 295100698 • White	YES, with LinQ Base Installation Kit 860201806 Can be installed inside* on the front cargo compartment.	NO	NO	NO	NO			
LinQ Tool Box 715008111								
LinQ SR 5.5 Gal (21 L) Bag 860202449	YES, with LinQ Base Installation Kit 860201806 Must be installed on the front cargo compartment lid only.							
LinQ 4.5 Gal (17 L) Sport Bag 860202447						YES, with LinQ Base Installation Kit 860201806		
LinQ Modular Box (10 L) 715005494						NO	NO	YES
LinQ Modular Box (20 L) 715007112	YES, with LinQ Base Installation Kit 860201806 Can be installed inside* on the front cargo compartment.							NO
LinQ Modular Box (30 L) 715006830								NO
LinQ Tool Kit 715006829								YES
LinQ Roll-Top Bag 715008110	YES, with LinQ Base Installation Kit 860201806 Must be installed on the front cargo compartment lid only.							NO
LinQ Fuel Caddy - 4 Gallons 860202246	YES, with LinQ Base Installation Kit 860201806 Must be installed inside* the front cargo compartment only.					NO	NO	NO
LinQ Oil Caddy - 1 Gallon 860202445								
LinQ Gun Case 715004968	YES, with LinQ Base Installation Kit 860201806 Must be installed on the front cargo compartment lid.							
LinQ Accessories with 36" Base	Front Cargo Compartment					Front Rack	Rear Cargo Compartment	Rear Rack
LinQ Large Cargo Box 715007001	NO	NO	NO	YES	NO			
LinQ Cargo Basket (90 L) 715005274								
LinQ Cargo Box (53 L) 715006997		YES	YES					
LinQ Low Profile Box (63 L) 715007827								
LinQ Trunk Box (139 L) 715006097			NO	YES, remove the rear rack for installation.	NO			
LinQ Trunk Box (145 L) 715005273			NO	NO	YES			
LinQ 9.2 Gal (35 L) Cooler 715006998			YES	NO	YES	NO		
LinQ Gun Case 715004968				NO	NO			
LinQ Holders and Racks		Front Cargo Compartment	Front Rack	Rear Cargo Compartment	Rear Rack	LinQ Can Stack on Top		
LinQ Gear Grips 715005340		YES, with LinQ Base Installation Kit 860201806	YES	YES, with LinQ Base Installation Kit 860201806	YES	NO		
LinQ Tool Holder 715007358								
LinQ Rack Extension 715004954	NO		NO					
LinQ Chainsaw Holder 715004975	YES	NO		NO				

*Removal of front cargo compartment lid is required.

LinQ Accessories with 16" Base

LinQ Fuel Caddy - 4 Gallons	G3L	860202246	\$239.99
------------------------------------	-----	------------------	-----------------



- Quick, easy and secure installation with LinQ system.
- No-spill spout for easy use.
- 3.7 US gallon (14 L) capacity.
- Meet the new latest Flame Mitigation Device (FMD) standard.
- Must be installed in the Front Cargo Compartment.
- LinQ Base Installation Kit (860201806) required.
- No LinQ 16" accessories can be stacked on the LinQ 4-Gallon Fuel Caddy.

LinQ Oil Caddy - 1 Gallon	G3L	860202445	\$139.99
----------------------------------	-----	------------------	-----------------



- 1 US gallon (3.78 L) capacity.
- Must be installed in the Front Cargo Compartment.
- LinQ Base Installation Kit (860201806) required.
- No LinQ 16" accessories can be stacked on the LinQ 1-Gallon Oil Caddy.

LinQ Chainsaw Holder	G3L (except X mr models)	715004975	\$179.99
-----------------------------	--------------------------	------------------	-----------------

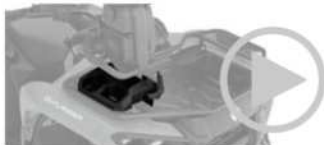

- This system installs a chainsaw vertically to save space on the rack and serves as a scabbard for storage.
- Pinch the blade for a solid and quick fix.
- Compatible with the majority of chainsaws available on the market as most blades go up to 18".
- Compatible with all 16" LinQ accessories that fit in the front cargo compartment.
- Allows installation of the LinQ Tool Holder.
- Not compatible with the LinQ Rack Extension when installed on the front rack of the vehicle.

LinQ Modular Box	G3L	715005494 · (10 L)	\$139.99
		715007112 · (20 L)	\$159.99
		715006830 · (30 L)	\$179.99



- Allows stacking of other modular boxes to always have the right gear accessible.
- Always have the right box size to fit everything.
- Can be installed on any LinQ Base with a 16" width.
- See table for installation location and requirements.

Thermal Insert for LinQ Modular Box (10 L)	G3L	219401110	\$55.99
---	-----	------------------	----------------



- Insulated liner.
- Fits very well in the LinQ Modular Box (10 L).
- Can contain seven 355 ml cans.
- Keeps ice cold for one day.
- Interior dimensions : 9" L x 17" W x 2½" H.

LinQ Tool Kit	G3L	715006829	\$309.99
----------------------	-----	------------------	-----------------



- Includes:
 - Cutter pliers
 - Long-nose pliers
 - Locking pliers
 - Ratchet wrench ¾" drive
 - 6" ratchet extension
 - Integrated CVT belt storage location (belt not included)
 - Long-socket 19 mm ¾" drive - 6 pts
 - Socket 18 mm ¾" drive
 - Long-socket 17 mm ¾" drive - 6 pts
 - Socket 15 mm ¾" drive
 - Socket 13 mm ¾" drive
 - Socket 10 mm ¾" drive
 - Socket 8 mm ¾" drive
 - Combined wrench 19 mm
 - Combined wrench 18 mm
 - Combined wrench 15 mm
 - Combined wrench 13 mm
 - Combined wrench 10 mm
 - Combined wrench 8 mm
 - Socket Torx T40 ¾" drive
 - Socket Torx T30 ¾" drive
 - Socket Torx T20 ¾" drive
 - Breaker bar ¾" drive
- See table for installation location and requirements.

LinQ 4.2 Gal (16 L) Cooler	G3L	■ 219400964 · Black	\$369.99
		■ 295100698 · White	



- All the benefits of LinQ—simple, fast and secure.
- Rotomolded construction for exceptional rigidity and durability.
- Premium-quality foam insulation for optimal ice retention.
- Uses LinQ mounting system (Patent US 8777531 and US 8875830).
- Easy one-second on/off toolless system.
- Can contain twenty 355 ml cans.
- Keeps ice cold for three days.
- Exterior dimensions: 13" L x 20" W x 10" H.
- Interior dimensions : 9" L x 17" W x 7" H.
- See table for installation location and requirements.

LinQ Tool Box	G3L	715008111	\$174.99
----------------------	-----	------------------	-----------------



- High precision injected HDPE construction provides rigidity and durability.
- 5 gal (19 L) maximum capacity.
- Weather-resistant, sealed and lockable cover.
- Marineized for salt water purposes.
- See table for installation location and requirements.

LinQ Roll-Top Bag	G3L	715008110	\$229.99
--------------------------	-----	------------------	-----------------



- Fully waterproof roll-top dry bag will securely store and confine your equipment.
- LinQ mounted using heavy-duty rigid plastic base.
- High capacity storage solution 10.6 gal (40 L).
- Bottom foam liner for additional equipment protection.
- Integrated handle for easy transportation on/off the vehicle.
- Marineized for salt water purposes.
- Dimensions: 14" L x 19" W x adjustable H.
- See table for installation location and requirements.

SR 5.5 Gal (21 L) LinQ Bag	G3L	860202449	\$224.99
-----------------------------------	-----	------------------	-----------------



- Semi-rigid expandable bag.
- 5.5 gal (21 L) capacity.
- See table for installation location and requirements.

LinQ 4.5 Gal (17 L) Sport Bag	G3L	860202447	\$204.99
--------------------------------------	-----	------------------	-----------------



- 4.5 gal (17 L) capacity.
- Rigid bottom, semi-rigid top.
- See table for installation location and requirements.

LinQ Accessories with 36" Base

LinQ Trunk Box (145 L)	G3L (except MAX models)	715005273	\$639.99
-------------------------------	-------------------------	------------------	-----------------



- Polyethylene Trunk Box replacing the rear rack for perfect integration and to increase cargo capacity.
- Storage capacity of 31 gal (145 L).
- Easy to install and remove with the LinQ system.
- LinQ anchors must be installed in the rear cargo compartment (4 LinQ anchors included).
- Possibility to install LinQ 16" accessories on the cover to increase the cargo capacity.
- New ergonomic and resistant latch system offers excellent sealing.
- Ability to install LinQ Tool Holders (715008896) on the box.
- Lockable with a lock on the front of the box (two keys included).

LinQ Trunk Box (139 L)	G3L (MAX models only)	715006097	\$639.99
-------------------------------	-----------------------	------------------	-----------------



- Polyethylene Trunk Box replacing the rear rack for perfect integration and to increase cargo capacity.
- Storage capacity of 30 gal (139 L).
- Easy to install and remove with the LinQ system.
- LinQ anchors must be installed in the rear cargo compartment (4 LinQ anchors included).
- Compatible with the passenger seat.
- New ergonomic and resistant latch system offers excellent sealing.
- Ability to install LinQ Tool Holders (715008896) on the box.
- Lockable with a lock on the front of the box (two keys included).

LinQ Cargo Box (53 L)	G3L	715006997	\$399.99
------------------------------	-----	------------------	-----------------



- Made of polyethylene.
- Storage capacity of 14 gal (53 L).
- Easy to install and remove with the LinQ system.
- Can be installed on the front or rear racks.
- New ergonomic and resistant latch system offers excellent sealing.
- Possibility to install LinQ 16" accessories on the cover and increase the cargo capacity.
- Ability to install LinQ Tool Holders (715008896) on the box.
- Lockable with a lock on the front of the box (two keys included).

NEW LinQ Low Profile Box (63 L)	G3L	715007827	\$399.99
--	-----	-----------	----------



- Made of impact-resistant injected polypropylene and weatherproof, this box has a storage capacity of 16.6 gal (63 L).
- LinQ mounted for efficient and secure storage, it is locked in place with only a quarter turn. Easy to install, easy to remove using the LinQ system.
- Can be installed in a 36" configuration only.
- LinQ 16" accessories can be installed on the cover to increase cargo capacity.
- Easily carried with the rigid handle. The antivibration system prevents the handle from moving while riding.
- Support feet at hinge levels so the box can stand on its own.
- The compact design allows for maximum rear field of vision.
- Features a lock on the front of the box (two keys included).

LinQ Cargo Basket (90 L)	G3L	715005274	\$239.99
---------------------------------	-----	-----------	----------



- Made of polyethylene.
- Storage capacity of 23 gal (90 L).
- Easy to install and remove with the LinQ system.
- Can be installed on the front or rear racks.
- Six handles on the contour to easily install bungee cords.
- Ability to install LinQ Tool Holders (715008896) to the basket.

Large Cargo Box	G3L	715007001	\$639.99
------------------------	-----	-----------	----------



- Rear bed to carry large items.
- Anchor points (D-ring), LinQ fixtures for tool holder, and marks to allow the installation of a 16" accessory.
- Also has a mat for the floor and slot to enable the installation of a divider and a slot for a divider to close the recess on the rear vertically.
- It is installed on ATV platforms through the LinQ system and hooks to make it easily installable and removable.

NEW LinQ 9.2 Gal (35 L) Cooler	G3L	715006998	\$599.99
---------------------------------------	-----	-----------	----------



- LinQ mounted for efficient and secure storage, locked in place with only a quarter turn.
- Easy to install, easy to remove using the LinQ system.
- Installation in LinQ 36" configuration.
- Made of polyethylene for exceptional rigidity and durability.
- Storage capacity of 9.2 gal (35 L).
- Lock the cooler on the vehicle using the LinQ Lock (60201968).
- Premium-quality foam insulation for optimal ice retention.
- Option to add a 5-slot LinQ Lite Rail on the side and at the rear of the cooler.
- A dry basket is included to protect your food from water.
- Drain plug at the bottom to get rid of excess water.
- The new ergonomic and resistant latch system ensures the top is tightly sealed.
- Innovative way to hold 12 cans (855 mL).
- Molded-in handles for quick installation and removal.

LinQ Rack Extension	G3L	715004954	\$199.99
----------------------------	-----	-----------	----------



- Easy to install and remove with the LinQ system.
- Fits front or rear of the vehicle.
- Provides tie-down points to secure cargo on racks.
- Made of steel with anticorrosion coating and durable powder-coat finish.
- Height of 7".

LinQ Holders

LinQ Tool Holder	G3L	715007358	\$54.99
-------------------------	-----	-----------	---------



- Ultra-versatile tool holder.
- Convenient swivel hatch allows tools to be stored in any orientation.
- Sold in pairs.

LinQ Gear Grips	G3L	715005340	\$144.99
------------------------	-----	-----------	----------



- Durable and flexible grips provide a custom fit for a variety of items from 1" to 4" (2.5 cm to 10 cm) in diameter.
- Heavy-duty design for carrying bows, fishing poles, rakes, farm tools and more.
- Quick-release button opens grip quickly for easy access to gear.
- Heavy-duty base system built for the toughest adventures.
- Make transporting your tools a snap by combining the Gear Grips with the LinQ system.
- 360° orientation.
- Sold in pairs.

LinQ Gear Grips	G 3L	715001421	\$87.99
------------------------	------	------------------	----------------



- Durable, flexible grips cushion and protect while providing a custom fit for a variety of items from 1" to 4" (2.5 cm to 10 cm) in diameter.
- Heavy-duty design for carrying bows, fishing poles, rakes, farm tools and more.
- Quick-release button opens grip quickly for easy access to gear.
- Heavy-duty base system built for the toughest adventures.
- Easy installation on tubular racks, extension racks, brackets or bumpers.
- Sold in pairs.

LinQ Gun Case	G 3L	715004968	\$269.99
----------------------	------	------------------	-----------------



- The practical design lets riders store shotguns and rifles up to 52" (132 cm), even with most optic configurations.
- Adapts to different weapon shapes and features with foam cushions that can be repositioned.
- The Gun Case is LinQ-mounted for efficient and secure storage, and is locked in place with only a quarter turn.
- The LinQ Gun Case must be installed on the front compartment lid using the LinQ Base Installation Kit (60201806), on the Front Rack or on fender position using the LinQ Gun Case Mounting Kit (715006074).

NEW LinQ Gun Case Mounting Kit - Fender Position	G 3L	715006074	\$119.99
---	------	------------------	-----------------



- This kit is required to install the LinQ Gun Case on fender position on G 3L, G 3LM AX and X models.
- Installs on the right side of the vehicle, and the safety system allows the driver or passenger to quickly exit the vehicle.
- The low-profile mounting system can be left on the vehicle year-round and doesn't get in the way when the Gun Case is not installed.

Holders

Tool Holder Bolt-On	G 3L	715008896	\$45.99
----------------------------	------	------------------	----------------



- Tool Holder is made to fit the LinQ Cargo Basket (60 L), LinQ Cargo Box (53 L), LinQ Trunk Box (139 L) and LinQ Trunk Box (145 L).
- Convenient swivel latch allows tools of all shapes to be stored in the proper orientation.
- Sold in pairs.
- Several degrees of adjustment.

Multi-Fit Holder	G 3L	715002354 • Single	\$62.99
		715001945 • Double	\$89.99



- Open U-shaped bracket for carrying tools (shovel, axe) and hunting weapons (rifle, bow) that are safely secured, but easily accessible.
- Easy installation on tubular rack, extension racks, basket or bumper.
- Sold in pairs.
- For G2, the LinQ Rack Extension (715001711) is required.

LinQ Mounting

LinQ Base Installation Kit	G 3L	860201806	\$38.99
-----------------------------------	------	------------------	----------------



- Unique mounting fastener usable on any LinQ system accessory.
- Included: 2 cargo LinQ bases and hardware.

LinQ Base	G 3L	715002350	\$24.49
------------------	------	------------------	----------------



- Made of polypropylene glass fiber.
- Allows you to install LinQ accessories.
- Sold in pack of 4.

LinQ Lock	G 3L	860201968	\$61.99
------------------	------	------------------	----------------



- Simple way to securely lock most LinQ accessories.
- Lock cover protects lock from the elements.
- Corrosion resistant.
- Pack of 1, includes 2 keys.
- Not compatible with LinQ 4.2 US Gal (16 L) Cooler, LinQ Toolbox, LinQ Tool Holder and LinQ Gear Grips.

CARGO & STORAGE



Soft Storage Bag (70 L)	G3L	715007002	\$219.99
--------------------------------	-----	-----------	----------



- Carry your gear in a weatherproof bag.
- Soft bag with a storage capacity of 18.5 gal (70 L) designed to maximize space in the front or rear of the vehicle.
- 3-compartment bag with removable dividers.
- Easy to install with strap system.
- X models: Fits on rear rack only.

CAN-AM WINDSHIELDS



Adventure High Windshield - Hardcoated	G3L (except X models)	715007268	\$249.99
---	-----------------------	-----------	----------



- Adventure windshield with three-position adjustable height.
- 14" (36 cm) high to protect against wind and winter weather.
- Made of injected polycarbonate with a thickness of 1/4" (4 mm) with ultra-resistant Quantum coating.
- Provides excellent optical clarity and better abrasion resistance.
- Console Extension (715005368) is required for installation.
- Side Wind Deflectors (715005862) available for added protection.

Adventure High Windshield	G3L (except X models)	715005377	\$199.99
----------------------------------	-----------------------	-----------	----------



- Adventure windshield with three-position adjustable height.
- 14" (36 cm) high to protect against wind and weather.
- Made of injected polycarbonate with a thickness of 1/4" (4 mm).
- Console Extension (715005368) is required for installation.
- Side Wind Deflectors (715005862) available for added protection.

Adventure Low Windshield	G3L (except X models)	715005860	\$179.99
---------------------------------	-----------------------	-----------	----------



- Adventure windshield with three-position adjustable height.
- 10 in (25 cm) high for wind protection.
- Made of injected polycarbonate with a thickness of 1/4" (4 mm).
- Console Extension (715005368) is required for installation.
- Side Wind Deflectors (715005862) available for added protection.

Adventure Side Wind Deflectors	G3L (except X models)	715005862	\$129.99
---------------------------------------	-----------------------	-----------	----------



- Side Wind Deflectors for additional wind protection.
- Easy installation.
- Console Extension (715005368) is required for installation.
- Works with Adventure Windshields (715005860, 715005377, 715007268).
- Not compatible with Integrated Audio System (715005354).

Console Extension	G 3L (except X m r m o d e l s)	715005368	\$199.99
--------------------------	---------------------------------	------------------	-----------------



- Integrated storage compartment (1 gal/4 L) with magnetic mount safe for your electronic device.
- Robust injected fiber-reinforced polypropylene construction makes it easy to fit and install.
- 25 times stronger than any smartphone weight, so you can ride through rough terrain confidently.
- Two possible positions for your electronic device: portrait and landscape.
- Includes everything needed for installation on your favorite electronic devices: two pre-assembled Can-Am plates with 3M multi-surface adhesive.
- Includes guide clips molded into the door to pass the charging cable.
- Possibility of installing USB outlet in storage compartment (USB power outlet sold separately).
- Required for the installation of the Adventure windshield and side wind deflectors.
- Not compatible with Snorkel Kit.
- Includes tether cord for additional peace of mind.

Console Extension USB Power Outlet	G 3L (except X m r m o d e l s)	715008750	\$69.99
---	---------------------------------	------------------	----------------



- Useful for the Console Extension (715005368) to plug your electronic device charger into the compartment.
- USB-A and USB-C ports.
- Rubber cap protects ports when not in use.
- Backlit to highlight the USB ports.
- Console Extension (715005368) is required for installation.

HANDLEBARS & MIRRORS



Driver Full Wrap Handguards	G 3L	■ 715005361 • Black ■ 715005362 • Neo Yellow	\$139.99
------------------------------------	------	--	-----------------



- Protects against wind, branches and debris.
- Rugged injected plastic deflection covers with Can-Am logo.
- Lightweight black die cast aluminum full wrap frame.
- New ergonomic design offers better comfort for the hand and increases protection.
- Mounting system leaves the handlebar free.
- Includes complete hardware.

Passenger Wind Deflectors	G 3L (MAX models only)	715001669	\$92.99
----------------------------------	------------------------	------------------	----------------



- These wind deflectors fit on the passenger handlebars and provide greater comfort while riding.
- Easy to install and remove.

Handlebar Mirrors	G 3L	715005366	\$69.99
--------------------------	------	------------------	----------------



- Adjustable handlebar mounted convex mirrors.
- The convex surface allows improved visibility with a wider field of view.
- Doesn't require a windshield or fairing to be mounted.
- Works with all windshield options.

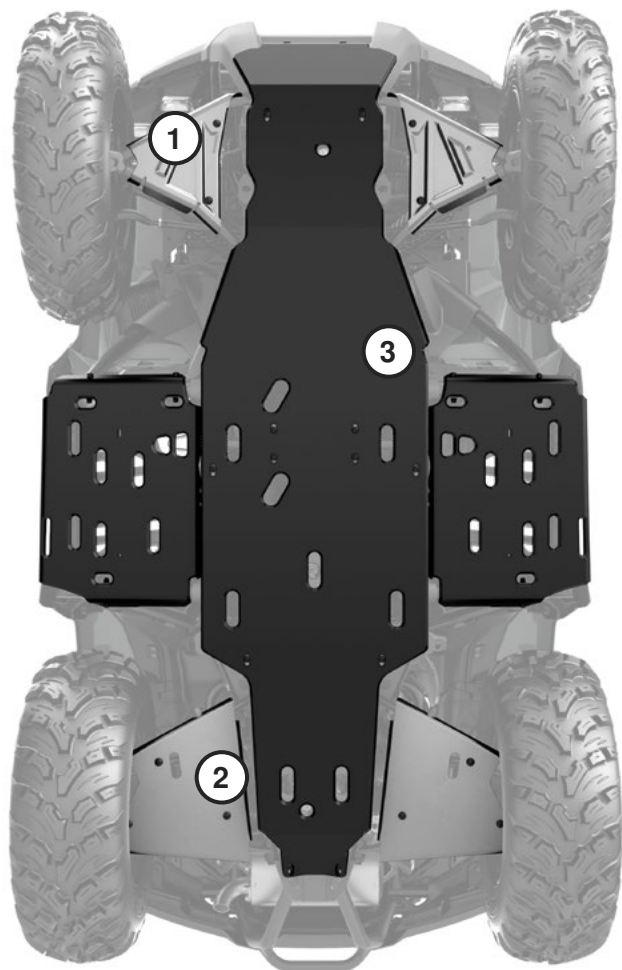

OUTLANDER

G3L

2023

Except MAX models

MAX models only

Skid Plate Protection Kit

715005309

715005310

Individual Skid Plates

① Front Aluminum A-Arm Protectors

715005305

715005305

② Rear Aluminum A-Arm Protectors

715005308

715005308

③ HM WPE Underbelly Plates

715005306

715005307

Our Skid Plates deliver the durability, strength, and reliability your adventures need. Protect the underbelly of your vehicle from front to rear, with folded ends at the footwells for a little extra. They combine materials for peak protection: with aluminum A-arms and a plastic underbelly, your ride can drive across rough terrain confidently.

- Quick and easy, bolt-on installation. No need to remove factory skid plates. No more rivets or rivnuts.
- Thicker underbelly plates (10 mm).

BUMPERS & GUARDS



Bumpers

XU Front Bumper	G 3L	715006614	\$319.99
------------------------	------	-----------	----------



- Heavy-duty tubular construction provides the most complete protection for your vehicle.
- Protects vehicle lights and corners.
- 7 1/2 inch compatible.
- Integrated tow hook.
- Similar to the XU models bumper.

XT Front Bumper	G 3L	715004952	\$169.99
------------------------	------	-----------	----------



- Provides additional protection for your vehicle against the elements.
- Tough and durable.
- Large tube construction with black powdercoat finish.
- Similar to stock bumper on XT models.
- Mounting plate included for tow hook.

Extreme Front Bumper Plate	G 3L (except X m models)	715005439	\$149.99
-----------------------------------	--------------------------	-----------	----------



- Ultra-robust construction provides additional protection to the front of the vehicle in rough terrain.
- Compatible with all front bumpers.

Front Tow Hook	G 3L	715008842	\$45.99
-----------------------	------	-----------	---------



- Provides a solid anchor when towing is needed or when transporting the vehicle.
- Allows you to attach most hooks or straps.
- This tow hook offers 3,500 lb (1,587 kg) of towing capacity.
- Made of forged steel.
- XT Front Bumper (715004952) required for installation.

Full Rear Bumper	G 3L	715008738	\$219.99
-------------------------	------	-----------	----------



- Provides additional protection for your vehicle against obstacles.
- Protects the rear lights of the vehicle without obstructing them.
- Strong and durable, must be added to the XT rear bumper (stock or accessory) for full protection.
- Wide and sturdy tubular construction with black powder-coat finish and metal corners.

XT Rear Bumper	G 3L (STD, DPS & X m models only)	715004953	\$129.99
-----------------------	-----------------------------------	-----------	----------



- Sturdy tubular construction.
- Protects the vehicle against obstacles.
- Standard on Outlander XT and Outlander PRO.
- Fits base models with grab bar only.
- Required to install the Full Rear Bumper.

Guards

Fender Flares	G 3L	715005349	\$129.99
----------------------	------	-----------	----------



- Kit is designed to deliver extra protection to your vehicle from dirt and debris. If you enjoy riding in the mud, it's a must.
- Made of injected plastic that hugs your vehicle fenders perfectly.
- Gives vehicle added flair for a rugged, cool look.
- Includes front and rear extensions and all mounting hardware.
- Not compatible with European vehicles.

ELECTRICAL & LIGHTS



Integrated Heated Grips & Thumb Throttle Combo

G3L

715005072

\$299.99



- Heat levels for grips and thumb displayed on vehicle screen.
- Ergonomic button integrated on LH grip.
- Single button for both grips and thumb heat selection.
- Five temperature settings for the thumb and grips.
- Adjustable heat ratio between grip and thumb warmer.
- Hold button to reach maximum heat quickly.
- Remembers your last heat setting.
- IP67-rated waterproof sealing keeps the elements out.
- ECE compliant.
- Plug-and-play installation.
- Clamp-on grips, no glue required.

Heated Passenger Grips & Visor Outlet

G3L MAX models only

715005358

\$349.99

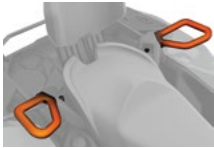

- Replace your stock passenger handles.
- Dual temperature switch integrated into seat arm for 3-zone heated handles and grips.
- Heated visor outlet integrated into seat arm.

Seat Heater

G3L

715007211

\$134.99



- 25 W seat heater delivers chill-free riding comfort.
- One temperature only.
- Heated pad and electrical harness only.
- Heavy-Duty Seat Cover (715008311) is required for installation on 1-up models.
- Heavy-Duty Seat Cover (715008313) is required for installation on 2-up models.

Heated Visor Outlet

G3L

715001246

\$56.99



- Strategically positioned on vehicle to maintain your agility.
- Optional visor outlet that delivers fog-free riding.
- Quick and easy installation.
- Sold individually.
- Heated Visor not included.

USB Intelligent Power Outlet Kit

G3L

715009117

\$59.99



- Power all your electronics with this easy-to-mount USB plug.
- Provides one USB-A 3.0 and one USB-C (PD) plug.
- Power rate: 36 watts.
- Intelligent USB charger for a fast charge when battery is low.
- Replaces the vehicle's 12 V socket.

NEW Cellphone Holder

G3L

715008786

\$99.99



- Water-resistant door allows for perfect phone positioning.
- Features capacitive and resistive touch screen technology.
- Spring system in back plate automatically adjusts for thickness.
- Fits all cellphones within 7.2" (185 mm) x 3.3" (85 mm) x 0.6" (15 mm) dimensions.
- Works with almost all charger wires.
- Does not include cellphone or charging wires.
- Requires the GPS RAM Mount for Handlebar (715001985) or the Console Extension (715005368) for installation.
- If installed on the Console Extension, the Console Extension USB Power Outlet (715008750) is required to charge cellphone.
- If installed on the Console Extension, Driver Full Wrap Handguards (715005361 or 715005362) are incompatible.

GPS RAM[†] Mount for Handlebar	G 3L	715001985	\$68.99
--	------	------------------	----------------



- Convenient bracket for installing the Garmin Montana GPS (715002830) or the Cellphone Holder (715008786) (not included) onto your unit's handlebar.

NEW Integrated Audio System	G 3L	715005354	\$879.99
------------------------------------	------	------------------	-----------------



- Fully integrated and weatherproof audio system.
- Includes two 6.5" front fender Bluetooth speakers giving you fingertip control of the tracks you're playing.
- Designed to be Can-Am tough in the most demanding riding conditions.
- Expertly tuned for exceptional sound, even when you're on the move on your Outlander.
- Comes with two speakers, each with 50 W dynamic power, for a total of 100 W dynamic power.
- Seamless integration and operation from any Bluetooth-enabled device, or via an auxiliary port.
- Plug-and-play audio system specifically designed not to drain the battery.
- Compatible with the Console Extension (715005368) and Adventure Windshields.
- Not compatible with the Adventure Side Wind Deflectors (715005862).
- EC compliant.

Note: We recommend you use 320 Kbps MP3 - 192-256 Kbps AAC or AIFF, WAV formats to match the potential of the speaker. More compressed formats will probably have degraded sound quality.

Bluetooth Handlebar Soundbar by MTX	G 3L	219400840	\$489.99
--	------	------------------	-----------------



- Bluetooth speaker with the unbeatable convenience of fingertip control.
- Rugged IP66-rated weather-resistant speaker designed for outdoor use.
- Driven by 150 watts of quality audio power.
- Seamless integration and operation from Bluetooth-enabled devices.
- Includes input, ground and ignition wires, plus auxiliary port and 3.5" (Ø 89 mm) connector cable.
- Not compatible with XT Handlebar Protector Kit.
- EC compliant.

Note: We recommend you use 320 Kbps MP3 - 192-256 Kbps AAC or AIFF, WAV formats to match the potential of the speaker. More compressed formats will probably have degraded sound quality.

3.5" (9 cm) LED Lights (2 X 14 W) LED Driving Lights	G 3L	715003666	\$254.99
---	------	------------------	-----------------



- 14 W LED lights producing 1,260 lumens each.
- Equipped with 6 high power LEDs in a heavy-duty die cast aluminum housing.
- Features 2 attachment points if one attachment point fails due to a collision, rotate to the next channel point and remount the light.
- Sold in pairs.
- EC compliant.
- Spot lens for a narrow and long light beam spread, ideal when driving at higher speeds.
- XT or XU Front Bumpers (715004952 and 715006614) and Light Power Cable (715005353) required for installation.
- Can also be installed on the stock front bumpers (KT and XU).

3.5" (9 cm) LED Lights (2 X 14 W) LED Flood Lights	G 3L	715003665	\$254.99
---	------	------------------	-----------------



- 14 W LED lights producing 1,260 lumens each.
- Equipped with 6 high power LEDs in a heavy-duty die cast aluminum housing.
- Features 2 attachment points if one attachment point fails due to a collision, rotate to the next channel point and remount the light.
- Sold in pairs.
- EC compliant.
- Flood lens for a wide light beam spread, ideal for working applications like plowing or for cornering, dusty or foggy riding conditions.
- XT or XU Front Bumpers (715004952 and 715006614) and Light Power Cable (715005353) required for installation.
- Can also be installed on the stock front bumpers (KT and XU).

10" (25 cm) Double Stacked LED Light Bar (60 W)	G 3L	715002933	\$369.99
--	------	------------------	-----------------



- Equipped with 12 5 W Cree LEDs.
- 5,400 lumens.
- Rugged and waterproof.
- Packs a big punch for its size.
- EC compliant.
- XT or XU Front Bumpers (715004952 and 715006614) and Light Power Cable (715005353) required for installation.
- Can also be installed on the stock front bumpers (KT and XU).

15" (38 cm) Double Stacked LED Light Bar (90 W)	G 3L	715002934	\$449.99
--	------	------------------	-----------------



- Equipped with 18 5 W Cree LEDs, 8,400 lumens.
- Complements the Light Racks and most bumpers.
- Rugged and waterproof.
- Lights up to more than 1,900 ft (580 m) in front of the vehicle and around 65 ft (20 m) wide on each side.
- EC compliant.
- XT Front Bumper (715004952) and Light Power Cable (715005353) are required for installation.
- Can also be installed on the stock front bumpers (KT and XU).

Light Power Cable (Not illustrated)	G3L	715005353	\$19.99
---	-----	-----------	---------

- Required for installation of the 10" (25 cm) and 15" (38 cm) LED Light Bars, as well as the 3.5" (9 cm) LED Lights.

RAM⁺ LED Spotlight	G3L	710005423	\$154.99
--------------------------------------	-----	-----------	----------



- 540 lumens LED light (Ø W) heavy-duty spotlight standard-equipped with 1" (2.5 cm) diameter rubber-coated double ball and socket system.

Battery Charger/ Maintainer		715005061	\$69.99
------------------------------------	--	-----------	---------



- Keeps stored lead-acid batteries charged.
- Charges and maintains small batteries.
- Microprocessor controlled multi-stage charging for added precision, safety and battery life.
- Automatically detects 6- or 12-volt batteries.
- Reverse hook-up protection helps protect battery and charger from damage.
- Auto-voltage detection.
- Press the display button to show the charge progress.
- Content: 3 amp battery charger, clamp adapter, DC adapter, 24" (61 cm) fused ring leads harness with weather cap, owners manual.
- Not EC compliant.

Jump Starter		715005062	\$139.99
---------------------	--	-----------	----------



- IPX3 water-resistant and enclosed output ports.
- 4 LED battery indicators for easy read on battery charge level.
- Compact design, will conveniently fit in your backpack, glove box or any other storage compartment.
- Ideal for powersports, motorcycles and 4 or 6 cylinder engines.
- 2.4A + 1A / 5V USB ports for fast charging of all USB devices.
- Smart cable provides protection against reverse polarity, short circuit, low voltage, high temperature and reverse charging.
- Built-in LED light (3 modes).
- Content: 300CA jump starter, SA858 smart cable clamp, MC-USB to USB charging cable, travel bag, user manual.
- Not EC compliant.

Quick Connect Battery Cable		715005408	\$10.49
------------------------------------	--	-----------	---------



- Quickly and easily connect and charge different items with your charger.
- Included in the Battery Charger/Maintainer (715005061).
- Sold individually.

Quick Connect Cable with Battery Indicator		715006055	\$22.49
---	--	-----------	---------



- Quickly and easily connect and charge different batteries with your charger.
- 3-color LED indicator provides constant battery health indication.
- Sold individually.



Can-Am HD Winches

Can-Am HD 2500 Winch	G 3L	715006973	\$369.99
-----------------------------	------	------------------	-----------------



- Ergonomic clutch handle.
- Rugged all-steel gears and bushings form ore torque and longer life.
- Automatic 100% load-holding brake.
- Coiled 10 ft. (3 m) weathersealed wired remote control (sold separately).
- Pulling strength capability of 2,500 lb (1,134 kg).
- 50 ft. of 1/2" (12.7 mm of 4.8 mm) wire steel cable.
- Heavy-duty 4-way roller fairlead.
- Weather-sealed handlebar mounted switch.
- Sealed solenoid for all weather protection.
- Plug-and-play wiring.
- A-am SEC and UKCA compliant.

Can-Am HD 3500 Winch	G 3L	715006974	\$399.99
-----------------------------	------	------------------	-----------------



- Ergonomic clutch handle.
- Rugged all-steel gears and bushings form ore torque and longer life.
- Automatic 100% load-holding brake.
- Coiled 10 ft. (3 m) weathersealed wired remote control (sold separately).
- Pulling strength capability of 3,500 lb (1,588 kg).
- 50 ft. of 5/8" (15.2 mm of 5.2 mm) wire steel cable.
- Heavy-duty 4-way roller fairlead.
- Weather-sealed handlebar mounted switch.
- Sealed solenoid for all weather protection.
- Plug-and-play wiring.
- A-am SEC and UKCA compliant.

Can-Am HD 3500-S Winch	G 3L	715008285	\$499.99
-------------------------------	------	------------------	-----------------



- Ergonomic clutch handle.
- Rugged all-steel gears and bushings form ore torque and longer life.
- Automatic 100% load-holding brake.
- Coiled 10 ft. (3 m) weathersealed, wired remote control (sold separately).
- Pulling strength capability of 3,500 lb (1,588 kg).
- 50 ft. of 1/2" (12.7 mm of 4.8 mm) synthetic rope.
- Heavy-duty Hawse fairlead.
- Weather-sealed handlebar mounted switch.
- Sealed solenoid for all weather protection.
- Plug-and-play wiring.
- A-am SEC and UKCA compliant.

Winch Accessories

Can-Am HD Wired Remote Control	Can-Am HD Winches (715008140/715008141/715006973/715009674/715008285)	715008121	\$30.99
---------------------------------------	--	------------------	----------------



- This kit allows owners to add a handheld remote to their winch or a stock winch.
- Works with the handlebar mounted switch.
- Wired Remote and Remote Socket included.
- 10 ft. wire.

Winch Accessories Kit		715002409	\$124.99
------------------------------	--	------------------	-----------------



- Get the most out of your winch.
- Double your pulling power, change your pulling direction and keep your winch in proper working order.
- Includes tree straps, snatch block, shackle and winching gloves.



Hitches

Front Receiver Hitch	G3L	715004977	\$99.99
-----------------------------	-----	-----------	---------



- Installs easily. No drilling required.
- This hitch offers a 1,500 lb (680 kg) towing capacity.
- Allows you to maneuver your trailer easily in tight, confined areas.
- Hitch bar sold separately.

Rear Hitch Drawbar Kit	G3L	715006230	\$99.99
-------------------------------	-----	-----------	---------



- Works on 2" (5 cm) standard receiver hitch.
- Offers a towing capacity of 3.8 kN (R = 750 kg).
- 50 mm Hitch Ball included.
- Forged steel.
- For European vehicles only.

Front and Rear Hitch Drawbar	G3L	715008350	\$99.99
-------------------------------------	-----	-----------	---------



- Standard on 2" (5 cm) receiver hitch.
- Offers 1,650 lb (750 kg) of towing capacity.
- Hitch ball not included.
- Forged steel.

Hitch Accessories

Rubber Receiver Plug		705204503	\$12.99
-----------------------------	--	-----------	---------



- Rubber cap for 2" (5 cm) hitch receiver.

PERFORMANCE

Performance

NEW Snorkel Kit

G 3L

715005073

\$379.99

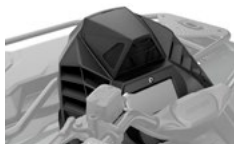

- Comprehensive snorkel kit for extended air intakes and CVT exhaust.
- The CVT outlet integrates into the pod cover.
- Ideal when riding in muddy conditions.
- Not compatible with windshield.
- Can be installed with the Integrated Audio System (715005354).

NEW Radiator Relocator Kit

G 3L

715004943

\$749.99



- Relocates radiator to top mount position.
- Prevents cooling performance loss in muddy conditions.
- Allows riders to open the relocator hood for easy radiator cleaning.
- Engineered for easy cooling system bleeding and maintenance.
- Includes support, hardware and hoses. Uses existing radiator; radiator not included.

Mud Strap

G 3L

715003053

\$47.99



- Convenient sturdy grab-handle.
- Lets drivers redistribute their weight for improved traction in demanding conditions.
- Not compatible with XT Handlebar Protector Kit (703100352).

Radiator Protector

G 3L (except X m rm odel s)

715005333

\$99.99



- Metal shield mounts over radiator face and protects vehicle from stones and branches.
- Slides easily out of its holder for easy cleaning.

NEW Heavy Duty Spring Kits

G 3L (except M AX & X m rm odel s)

715008202 •Front
715004942 •Rear

\$149.99



- Allows riders to replicate the standard HD 5/HD 7 suspension setup on the Outlander 500/700 (L-up).
- The heavy-duty springs improve handling and provide enhanced stiffness, which is perfect for snow clearing and hauling heavy loads.
- Two springs included in the kit.

NEW Aluminum Footpeg Kit

G 3L

715008199

\$59.99



- Provides maximum integrated grip and stability during vigorous riding.
- The kick-up end gives riders added grip during hard cornering.
- Made of aluminum, sold in pairs.

Emergency Accessories

Emergency Kit

715006102

\$159.99



- Complete emergency kit provides all essential equipment and supplies to get out of most unfavorable situations power sport enthusiasts may find themselves in.
- Includes jump cables, air compressor, tire repair kit, first-aid kit, ratchet tie-down, duct tape, 3,300 lb (1,500 kg) tow strap, zip ties and cloth rags.

COVERS & ADDONS



NEW Heavy-Duty Seat Cover	G3L (except MAX models)	715008311	\$59.99
----------------------------------	-------------------------	------------------	----------------



- Heavy-duty materials to cover and protect the seat.
- Designed to fit the vehicle's lines perfectly.
- Abrasion- and tear-resistant.
- Easily installed by stretching around the original seat; the elastic holds the cover securely in place.

NEW Heavy-Duty Seat Cover	G3L MAX models only	715008313	\$79.99
----------------------------------	---------------------	------------------	----------------

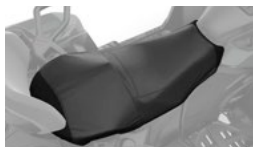

- Heavy-duty materials to cover and protect the seat.
- Designed to fit the vehicle's lines perfectly.
- Abrasion- and tear-resistant.
- Easily installed by stretching around the original seat; the elastic holds the cover securely in place.

Trailer Cover	G3L (except MAX models)	715005074	\$229.99
	G3L MAX models only	715005075	



- Weather-resistant trailer cover protects your vehicle during storage and transportation.
- Heavy-duty canvas made of UV-resistant solution-dyed polyester.
- Inner soft liner protects windshield and colored panels from abrasion.
- Quick and easy clip-on installation.
- Designed with the vehicle to fit its lines perfectly for less wind resistance and less water accumulation.
- Can be installed with or without Can-Am accessories.

Flag	715000277 • Yellow	\$32.99
-------------	---------------------------	----------------



- Make sure everyone knows what you're riding.
- Perfect for dunes and new riders.
- 8-ft. (2.4 m) length.
- Includes flag mount (715000127).

Flag Mount <i>(Not illustrated)</i>	715000127	\$20.99
---	------------------	----------------

Ratchet Tie-Downs	715008309 • Black/Gray	\$24.49
--------------------------	-------------------------------	----------------



- 400 lb (181 kg) safe working load.
- 1" x 10 (2.5 cm x 3 m) strap with Can-Am, Sea-Doo, and Ski-Doo logos.
- Deluxe ratchet with rubber handle.
- Coated S hooks.
- Pack of 2.

Heavy-Duty Ratchet Tie-Down	715008308	\$44.99
------------------------------------	------------------	----------------



- 1,000 lb (454 kg) safe working load.
- 1.5" x 6 (38 mm x 1.8 m) strap with BRP brands.
- Deluxe ratchet with rubber handle.
- Black-coated clip hooks.
- 12 (300 mm) webbing included.
- Pack of two.



APACHE TRACK SYSTEMS FITTING GUIDE

Apache Backcountry

Model Year / Model	Track	Track Mount	Track DPS Module	Engine Pre-filter	CVT Pre-filter
2023 G3L	715005247	715004993	715007338 (without IFC) OR 715006266 (with IFC)	715008314	Not required

Apache 360 and Apache 360 LT

Model Year / Model	Track	Track Mount	Track DPS Module	Engine Pre-filter	CVT Pre-filter
2023 G3L	715006323 (Apache 360) OR 715005103 (Apache 360 LT)	715004992	715007338 (without IFC) OR 715006266 (with IFC)	715008314	Not required

Apache Backcountry

Apache Backcountry Track System	G3L	715005247
---------------------------------	-----	-----------



- Designed to deliver the best flotation level and deep-snow performance on the market.
- Contact patch is 23% bigger than the Apache 360 LT.
- Ingressive added ground clearance of 7" (18 cm), keeps the vehicle out of deep snow.
- Aggressive track design with 2" (5 cm) lug height for maximum traction on snow.
- Apache Backcountry Mounting Kit and engine and air intake pre-filters are required.
- For winter use only.

Idler Wheel Kit	Apache Backcountry Track System (rear tracks only)	860201230 • 141 mm
-----------------	--	-----------------------



- Reduces drag and rolling resistance.
- Includes 2 wheels, brackets and hardware.
- Add up to 2 kits per rear track.
- Can extend idler life in hardened snow conditions.

Rail Ice Scratchers	Apache Backcountry Track System	860201728
---------------------	---------------------------------	-----------



- Provide additional lubrication in hard and icy conditions.
- Rail mounted, small, light.
- Design expands on coil concept to allow reversing without damage.
- Easily stored when not in use.

Apache 360 & 360 LT

Apache 360 Track System

G3L

715006323



- Multifunctional tracks perfect for any Can-Am ATV.
- Average ground clearance of 16" (41 cm).
- 1" (2.5 cm) lugs in the front and 1.25" (3.2 cm) in the back.
- Apache 360 and 360 LT Mounting Kit and engine and air intake pre-filters are required.
- EC compliant.

Apache 360 LT Track System

G3L

715005103



- Multifunctional tracks designed to support heavy loads and to fit on most Can-Am Off-Road vehicles.
- Front wheel height adjustment provides enhanced attack angle and better performance over rough terrain when raised or increased contact patch for improved flotation when lowered.
- Average ground clearance of 16" (41 cm).
- 1" (2.5 cm) lugs in the front and 1.25" (3.2 cm) in the back.
- Reliable heavy-duty build.
- EC compliant.
- Contact patch is 7 to 9% bigger than the Apache 360s.
- Apache 360 and 360 LT Mounting Kit, Track DPS Module and Engine and Air Intake Pre-filters are required.

Apache Accessories

Apache Backcountry Mounting Kit

(Not illustrated)

G3L

715004993

- Required to install Apache Backcountry Track System.
- DPS module and pre-filter not included.
- Improved installation time and switch seasons faster than ever.

Apache 360 & 360 LT Mounting Kit

(Not illustrated)

G3L

715004992

- Required to install Apache 360 and 360 LT Track Systems.
- DPS module and pre-filter not included.
- Improved installation time and switch seasons faster than ever.

Track DPS Module

(Not illustrated)

G3L (with IIC)

715006266

- An innovative DPS module that ensures speedometer accuracy and optimized steering assist, which make for perfect track control and riding ease.
- Required to install the Apache and Backcountry Track Systems.



PROMOUNT FLOW KITS

Steel Reference Chart

	54" Black Steel	54" Yellow Steel	60" Black Steel	60" Yellow Steel	66" Black Steel	66" Yellow Steel	72" Black Steel	72" Yellow Steel
Plow Kit	715006202	715006206	715006203	715006207	715006205	715006208		
Blade	715004472	715005316	715004202	715005317	715006337	715006338	715004474	715006021
Push Frame	715004980	715004980	715004980	715004980	715004980	715004980	715004980	715004980
Mounting Kit	715009483	715009483	715009483	715009483	715009483	715009483	715009483	715009483

Flex2 Reference Chart

	60" Flex2	66" Flex2	72" Flex2
Plow Kit	715006204	715008206	
Blade	715004203	715006265	715004485
Push Frame	715004980	715004980	715004980
Mounting Plate	715009483	715009483	715009483

Steel Plows

Can-Am ProMount 54" (137 cm) Steel Plow Kit

G 3L

■ 715006202 •Black
■ 715006206 •Yellow

\$949.99



- This kit includes:
- Can-Am ProMount Steel Blade
 - Push Frame with Quick-Attach System
 - Mounting Kit
 - Plow Roller Fairlead

Can-Am ProMount 60" (152 cm) Steel Plow Kit

G 3L

■ 715006203 •Black
■ 715006207 •Yellow

\$979.97



- This kit includes:
- Can-Am ProMount Steel Blade
 - Push Frame with Quick-Attach System
 - Mounting Kit
 - Plow Roller Fairlead

Can-Am ProMount 66" (168 cm) Steel Plow Kit

G 3L

■ 715006205 •Black
■ 715006208 •Yellow

\$1,029.97



- This kit includes:
- Can-Am ProMount Steel Blade
 - Push Frame with Quick-Attach System
 - Mounting Kit
 - Plow Roller Fairlead

Can-Am ProMount Steel Blades 54" (137 cm) Blade	Fits ProMount Push Frame	■ 715004472 •Black ■ 715005316 •Yellow	\$329.99
--	--------------------------	---	-----------------



- Blades available individually to create your own kit.
- Compatible with Can-Am ProMount Blade accessories to further enhance plow versatility (some plow accessories are not compatible with 54" (137 cm) plows).
- Not compatible with ProMount Diff Cutters, Blade Extensions and Edge Markers.
- Clears 50" (127 cm) when plow is fully angled.
- Blade height of 14.75" (37 cm).

Can-Am ProMount Steel Blades 60" (152 cm) Blade	Fits ProMount Push Frame	■ 715004202 •Black ■ 715005317 •Yellow	\$359.99
--	--------------------------	---	-----------------



- Blades available individually to create your own kit.
- Compatible with Can-Am ProMount Blade accessories to further enhance plow versatility.
- Clears 54" (137 cm) when plow is fully angled.
- Blade height of 17" (43 cm).

Can-Am ProMount Steel Blades 66" (168 cm) Blade	Fits ProMount Push Frame	■ 715006337 •Black ■ 715006338 •Yellow	\$409.99
--	--------------------------	---	-----------------



- Blades available individually to create your own kit.
- Compatible with Can-Am ProMount Blade accessories to further enhance plow versatility.
- Clears 60" (152 cm) when plow is fully angled.
- Blade height of 17" (43 cm).

Can-Am ProMount Steel Blades 72" (183 cm) Blade	Fits ProMount Push Frame	■ 715004474 •Black ■ 715006021 •Yellow	\$479.99
--	--------------------------	---	-----------------



- Blades available individually to create your own kit.
- Compatible with Can-Am ProMount Blade accessories to further enhance plow versatility.
- Clears 66" (168 cm) when plow is fully angled.
- Blade height of 17" (43 cm).

Can-Am ProMount Flex2 Plow Kit

Can-Am ProMount 60" (152 cm) Flex2 Plow Kit	G3L	■ 715006204 •Black	\$1,059.97
--	-----	--------------------	-------------------



- This kit includes:
- Can-Am ProMount Flex2 Blade
 - Push Frame with Quick-Attach System
 - Mounting Kit
 - Plow Roller Fairlead

Can-Am ProMount 66" (168 cm) Flex2 Plow Kit	G3L	■ 715008206 •Black	\$1,129.97
--	-----	--------------------	-------------------



- This kit includes:
- Can-Am ProMount Flex2 Blade
 - Push Frame with Quick-Attach System
 - Mounting Kit
 - Plow Roller Fairlead

Can-Am ProMount Flex2 Plows

Can-Am ProMount Flex2 60" (152 cm) Blade	Fits ProMount Push Frame	715004203	\$439.99
---	--------------------------	------------------	-----------------



- Plow blade made of UHMWPE, flexible and impact absorbing material prevents damaging your plow when accidental impacts occur.
- Replaceable wear blade.
- Large pin designed for easy blade rotation to eliminate snow buildup at pivot point.

- Blade design provides best snow rolloff at any angle.
- Compatible with Can-Am ProMount Blade accessories to further enhance plow versatility.
- Clears 54" (137 cm) when plow is fully angled.
- Blade height of 17" (43 cm).

Can-Am ProMount Flex2 66" (168 cm) Blade	Fits ProMount Push Frame	715006265	\$509.99
---	--------------------------	------------------	-----------------



- Plow blade made of UHMWPE, flexible and impact absorbing material prevents damaging your plow when accidental impacts occur.
- Replaceable wear blade.
- Large pin designed for easy blade rotation to eliminate snow buildup at pivot point.

- Blade design provides best snow rolloff at any angle.
- Clears 60" (152 cm) when plow is fully angled.
- Blade height of 17" (43 cm).
- Compatible with Can-Am ProMount Blade accessories to further enhance plow versatility.

Can-Am ProMount Flex2 72" (183 cm) Blade	Fits ProMount Push Frame	715004485	\$589.99
---	--------------------------	------------------	-----------------



- Plow blade made of UHMWPE, flexible and impact absorbing material prevents damaging your plow when accidental impacts occur.
- Replaceable wear blade.
- Large pin designed for easy blade rotation to eliminate snow buildup at pivot point.

- Blade design provides best snow rolloff at any angle.
- Compatible with Can-Am ProMount Blade accessories to further enhance plow versatility.
- Clears 66" (168 cm) when plow is fully angled.
- Blade height of 17" (43 cm).

Angle Plows

Can-Am ProMount Angle Blades 60" (152 cm) Steel Oneway State Blade	G3L	715007261	\$419.99
---	-----	------------------	-----------------



- Make the job easier with the right tools, clear long alleys and make the task easier by sending the snow further out of the way.
- Wing end of plow measures 25" (63 cm) high and tapers down to 17" (43 cm).
- One-way winged state plow designed to throw snow higher.
- Rubber Flap (715007299) designed to keep snow away from the driver is offered as accessory (sold separately).
- Can-Am branded.

Can-Am ProMount Angle Blades 66" (168 cm) Steel Oneway State Blade	G3L	715007263	\$489.99
---	-----	------------------	-----------------



- Make the job easier with the right tools, clear long alleys and make the task easier by sending the snow further out of the way.
- Wing end of plow measures 25" (63 cm) high and tapers down to 17" (43 cm).
- One-way winged state plow designed to throw snow higher.
- Rubber Flap (715007299) designed to keep snow away from the driver is offered as accessory (sold separately).
- Can-Am branded.

Can-Am ProMount Angle Blades 72" (183 cm) Steel Oneway State Blade	G3L	715007264	\$539.99
---	-----	------------------	-----------------



- Make the job easier with the right tools, clear long alleys and make the task easier by sending the snow further out of the way.
- Wing end of plow measures 26" (67 cm) high and tapers down to 17" (43 cm).
- One-way winged state plow designed to throw snow higher.
- Rubber Flap (715007299) designed to keep snow away from the driver is offered as accessory (sold separately).
- Can-Am branded.

ProMount One-Way State Blade Rubber Flap (Not illustrated)		715007299	\$119.99
--	--	------------------	-----------------

- Allows for more efficient snow projections in various snow conditions.

Can-Am ProMount Plow Accessories

Can-Am ProMount Push Frame with Quick-Attach System

G3L

715004980

\$499.99



- Heavy-duty steel tubes designed to withstand the roughest use.
- Mount location provides the ultimate push strength and traction.
- Designed for maximum plow lift height.
- Features a self-aligning quick-attach system, an easy foot-release pedal and an ergonomic handle for plow angle adjustment.
- Allows blade to swivel left or right in five positions.
- Compatible with all Can-Am ProMount blades.
- Plow Roller Fairlead and Plow Limit Switch recommended to extend winch cable lifespan.
- Can-Am ProMount Mounting Kit required for installation.

Can-Am ProMount Push Frame Extension

G3L

715006257

\$174.99



- 12" (30 cm) push frame extension.
- Required when plow is installed with Apache Track System.

NEW Can-Am ProMount Mounting Kit

G3L

715009483

\$119.99



- Required to install the Can-Am ProMount Push Frame with Quick-Attach System.
- 20 mm mounting rods are designed to stay in place all year round without compromising on ground clearance.
- No drilling required.
- Quick installation directly to the chassis.
- Plow Roller Fairlead included.

Can-Am ProMount Edge Markers

G3L

715004206

\$45.99



- Help locate the edges of your plow.
- Height: 24" (60 cm).
- Sold in pairs.
- Compatible with Can-Am ProMount Steel and Flex2 Blades with or without Blade Extensions (except for the Can-Am ProMount Steel 54" (137 cm) Blades).

Can-Am ProMount Drift Cutters

G3L

715004207

\$124.99



- Help keep snow in the plow.
- Dimensions: 17" x 13" (43.2 cm x 33 cm).
- Sold in pairs.
- Compatible with Can-Am ProMount Steel and Flex2 Blades with or without Blade Extensions (except for the Can-Am ProMount Steel 54" (137 cm) Blades).

Can-Am ProMount Plastic Wear Blade

G3L

715004480 • 54" (137 cm)

\$139.99

715004481 • 60" (152 cm)

\$159.99

715004482 • 66" (168 cm)

\$179.99



- To help prevent scratches on smooth driveways and markable surfaces.

Can-Am ProMount Curved Wear Blade

G3L

715007791 • 60" (152 cm)

\$114.99

715007792 • 66" (168 cm)

715007793 • 72" (183 cm)



- Wear blade designed with a folded back bottom lip.
- The increased surface allows for less digging while plowing uneven surfaces.
- Ideal for snow covered gravel, grass, paver stone and other soft surfaces.

Can-Am ProMount Plow Blade Extensions	G3L	<ul style="list-style-type: none"> ■ 715004205 · Black ■ 715005319 · Yellow 	\$119.99
--	-----	---	-----------------



- Add 3" (8 cm) each side.
- Compatible with Can-Am ProMount Blades (except for Can-Am ProMount Steel 54" (137 cm) Blade).
- Longer Wear Blade can be installed to further extend the extra length already provided by the extensions.
- Compatible with Can-Am ProMount Steel and Flex2 Blades (except for the Can-Am ProMount Steel 54" (137 cm) Blades).

Back Drag Blade	ProMount Plows (60" and more)	715007794	\$279.99
------------------------	-------------------------------	------------------	-----------------



- ¼" thick steel swivel scraper.
- Lifts up when the vehicle is moving forward so as not to affect the scraping.
- Increased capacity to pull snow.
- More aggressive scraping in reverse mode.
- Lifts the blade off the ground so that it scrapes evenly.
- Adjustable in length for compatibility with 60", 66" and 72" blades.
- Compatible with ProMount blades (Flex and Steel).

Plow Roller Fairlead	G3L	705009222	\$69.99
-----------------------------	-----	------------------	----------------



- Larger diameter lower roller reduces wear on wire rope for plow application.
- Can be used with all ProMount plows.
- Included in the Can-Am ProMount Mounting Kit (715009483).

Pulley Kit for Alpine Super-Duty Plow	G3L	715000279	\$57.99
--	-----	------------------	----------------



- Pulley kit to be used in conjunction with the winch when using a snow plow.
- Recommended to increase winch efficiency.
- To be used with the XT Front Bumper.

Plow Limit Switch <i>(Not illustrated)</i>	G3L	715006319	\$134.99
--	-----	------------------	-----------------

- To control the cable tension when raising your plow system.
- Prevents winch, plow push frame and vehicle damage.

Can-Am ProMount Plow Angling System	G3L	715007801	\$799.99
--	-----	------------------	-----------------



- Converts your plow system into an easy-to-control unit from the driver's seat.
- Using one hand to control all plow motions will allow you to easily concentrate and manage your plowing tasks.
- Compatible with ProMount Blade.
- Push Frame (715004980) is required.
- Push Frame Extension (715006257) is required for installation with the Front Rancher Bumper.
- Winch and plow sold separately.





PARTS AND MAINTENANCE

PARTS AND MAINTENANCE

Keep an Eye on These Parts	112
Genuine Parts	114
XPS Tires	117
Tires & Rims	118
Lubricant & Oil Change Kit	121
Maintenance Products	122
Care Products	123



CAN-AM TOUGH

Trust genuine Can-Am parts to keep your vehicle performing at its best.

ONE YEAR WARRANTY

Precisely engineered. Rigorously tested. Factory approved.

*Covers parts and labor when fitted at an authorized dealer.



To make sure your ATV performs as you expect,
keep an eye on these components:*

OIL FILTER 420256188

ENGINE OIL

4T 10W-50 Synthetic Oil
 1 quart / 946 ml 9779234
 1 US gallon / 3.785 L 9779235

4T 0W-40 Synthetic Oil
 1 quart / 946 ml 9779139
 1 US gallon / 3.785 L 9779140

4T 5W-40 Synthetic Blend Oil
 1 quart / 946 ml 9779133
 1 US gallon / 3.785 L 9779134

OIL CHANGE KIT

5W-40 Synthetic Blend Oil
 500 cc or more V-twin engine 9779258

0W-40 Synthetic Oil
 500 cc or more V-twin engine 9779259

10W-50 Synthetic Oil
 500 cc or more V-twin engine 9779252

5W-40 Synthetic Blend Oil
 450cc or less 9779256

0W-40 Synthetic Oil
 450cc or less 9779257

FUEL FILTER 709001120

AIR FILTER

Performance Air Filter
 by Twin Air 715001333

Premium Air Filter 707800371

CVT AIR FILTER

G2S 707001786

G2, G2L 715003483

DRIVE BELT

450 cc & less
 Premium (stock) 422280283

500 cc & more
 Premium (stock) 422280360

BRAKE PADS

Metallic G2
 Front & Rear Left 715900248
 Front & Rear Right 715900249

Organic G2, G2L, G2S
 (except Xmr models)
 Front & Rear Left 715601015
 Front & Rear Right 715601014

CV BOOT KITS

G2, G2L, G2S
 (except Xmr models)
 Front Wheel Side 705401345
 Front Differential Side 705401346
 Rear 705501864

Xmr models
 Front Wheel Side 705401354
 Front Differential Side 705401355
 Rear 705501864

WHEEL BEARINGS 293350150

A ARM BUSHING KIT 703500875

BALL JOINTS

Upper 706202044
 Lower 706202045

SPARK PLUG

450, 850, 1000R engines 715900352

570, 650, 1000 engines 715900642

BATTERY

G2S, G2, G2L
 18 Amps Wet (TX20 L-BS) 296000444

DS (250, 90, 70, 50)
 13 Amps Wet
 (TX16 L-BS) V31500M AA020

**Refer to periodic maintenance chart for proper intervals.

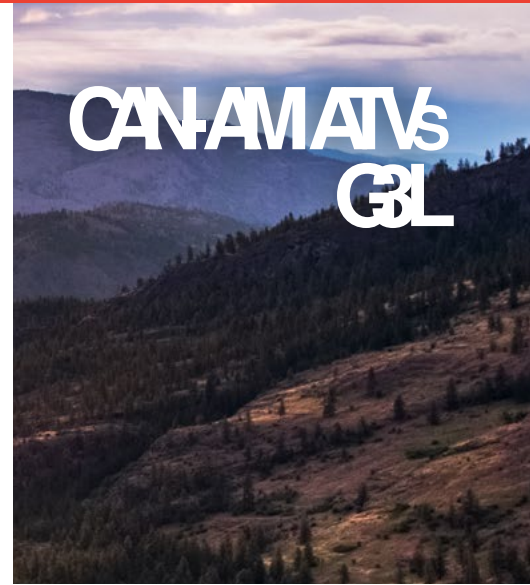

To make sure your ATV performs as you expect,
keep an eye on these components:**

Oil Filter	420256188
Oil Filter Cover O-Ring	420230922
Drain Plug Sealing Ring	420552280
Engine Air Filter	707800846
Spark Plug	715900785
Belt for 700/ HD7	420280225
Belt for 500/ HD5	420280226
Front Left Brake Pad	705602070
Front/ Rear Right Brake Pad	705602071
Front CV Outer Boot Kit G3L	715500456
Front CV Inner Boot Kit G3L	715500457

Rear CV Outer Boot Kit G3L	715500464
Rear CV Inner Boot Kit G3L	715500465
Wheel Bearing	293350150
Suspension Bushing	706004511
Ball Joints Lower	706202045
Ball Joints Upper	706202044
Battery	296000444
pDrive Ramp Roller Maintenance Set	420629231
pDrive Torque Roller Maintenance Set	420629225

**Refer to periodic maintenance chart for proper intervals.

GENUINE PARTS

Oil Filters

Oil Filters	Models	Oil Filter		Sealing Ring (Oil Filter Cover)		Sealing Ring (Drain Plug)	
	G 2S, G 2 & G 2L	420256188	\$12.99	420230923	\$2.99	420552280	\$3.49
	G 3L	420256188	\$12.99	420230922	\$0.87	420552280	\$3.49

Complete Engine Oil Change Kit also available see page 122

Air Filters

Premium Air Filter	Models	Oil Filter	Sealing Ring (Oil Filter Cover)	Sealing Ring (Drain Plug)
	G 2S, G 2 & G 2L	707800371		\$49.99
	G 3L	707800846		\$49.99

- Premium quality filter.
- Prevents airborne contaminants from reaching your engine.
- Protects internal components against premature wear.

Performance Air Filter by Twin Air†	Models	Oil Filter	Sealing Ring (Oil Filter Cover)	Sealing Ring (Drain Plug)
	G 2S, G 2 & G 2L	715001333		\$73.99

- The best choice for the harshest conditions.
- Multiple staged oiled filtering foam for superior dust retaining capacity with high air flow.
- Washable and reusable.

CVT Air Filter <i>(Not illustrated)</i>	Models	Oil Filter	Sealing Ring (Oil Filter Cover)	Sealing Ring (Drain Plug)
	G 2, G 2L	715003483		\$51.99
	G 2S	707001786		\$17.49
	G 3L	707002886		\$18.49

Spark Plug

Spark Plug	Models	Oil Filter	Sealing Ring (Oil Filter Cover)	Sealing Ring (Drain Plug)
	ATV 450/850/1000R	715900352		\$19.99
	ATV 570/650/1000	715900642		\$5.69
	ATV 500/700	715900785		\$19.99

Batteries

Yuasa† Batteries	Models	3 A Wet (YTX4 L-BS)	10 A Wet (YTX12-BS)	18 A Wet (YTX20 L-BS)
	G 2S, G 2 & G 2L			296000444 \$159.99
	G 3L			296000444 \$159.99
	D S 50, 70 & 90	V31500M AA020 \$114.99		
	Renegade 70, 110	V31500M AA020 \$114.99		
	D S 250		715900031 \$124.99	

- Top of the line models from the leading preferred original equipment battery suppliers in North America.

Axles

Premium CV Axle

- Premium quality design ideal for offroading, heavy-duty and low speed torque usage.
- Includes CVs, shaft and boots with the best suited geometry for your Can-Am vehicle.



Models	Front Left		Front Right		Rear Left		Rear Right	
G2, G2S (except X m r)	705402235	\$229.99	705402236	\$229.99	705502710	\$229.99	705502711	\$229.99
G2, G2S X m r	705403009	\$259.99	705402238	\$259.99	705503025	\$229.99	705503024	\$229.99
G2L (except 570 X m r)	705401429	\$229.99	705401428	\$229.99	705501898	\$229.99	705501897	\$229.99
G2L 570 X m r	705401115	\$229.99	705401116	\$229.99	705501485	\$229.99	705501486	\$229.99
G3L (non ABS models)	705402251	\$229.99	705402250	\$229.99	705502928	\$229.99	705502928	\$229.99
G3L (ABS models)	705402612	\$229.99	705402613	\$229.99	705502928	\$229.99	705503078	\$259.99

Brakes

Metallic Brake Pad Kit

- Built strong to last long heavy-duty construction stands up to hard braking.
- Designed to handle demanding riding conditions with challenging braking environments such as mud and dunes.
- Created specifically for use with Can-Am vehicles.



Models	Front Left		Front Right		Rear Left		Rear Right	
G2S, G2 & G2L	715900248	\$43.99	715900249	\$43.99	715900248	\$43.99	715900249	\$43.99
G3L	705602070	\$48.99	705602071	\$57.99	N/A		705602071	\$57.99

Please contact your dealer or visit our online store at canamoffroad.com for suggested fitment.

Parts

A-Arm Bushing Kit

G2, G2L, G2S

703500875

\$15.49



- This bushing kit includes 2 bushings, a sleeve and a wear plate, as illustrated.
- All you need to renew your suspension A-arms.

Ball Joints

Upper

706202044

\$36.99

Lower

706202045

\$44.99



- Robust design for offroad usage and sealed for prolonged durability.

Wheel Bearings

(Not illustrated)

G2, G2L, G2S, G3L

293350150

\$49.99

- Sealed bearings for additional protection from water and dirt.

CV Boot Kit

- Comes with clamps and grease.
- Genuine BRP CV Boot Kits ensure absolute compatibility and a perfect fit.



Models	Front Wheel Side		Front Differential Side		Rear Wheel Side		Rear Differential Side	
G2, G2L, G2S (except X m r)	705401345	\$39.99	705401346	\$39.99	705501864	\$39.99	705501864	\$39.99
X m r	705401354	\$39.99	705401355	\$39.99	705501864	\$39.99	705501864	\$39.99
G3L	715500456	\$39.99	715500457	\$39.99	715500464	\$39.99	715500465	\$39.99

Belts

BRP Premium Drive Belt

- High-performance design ideal for off-road use.
- BRP-specific calibration adjusted to best suit your Can-Am vehicle.



Models	Premium Belt		CVT Gasket Cover	
G2, G2S 450 cc & less	422280283	\$94.99	420430126	\$38.99
G2, G2S 500 cc & more	422280366	\$169.99	420430126	\$38.99
G2L Outlander 450 & Outlander MAX 450	422280283	\$94.99	420630292	\$29.99
G3L 500/HD 5	420280226		420630255	\$29.99
G3L 700/HD 7	420280225	\$194.99	420630255	\$29.99

Driven Clutch Spreader Tool

(Not illustrated)

G2, G2L, G2S, G3L

529036098

\$19.49

- Allows you to spread the secondary clutch open for easy belt replacement.

pDrive Pulley Service Kits

Ramp Roller Maintenance Set

G3L

420629237

\$124.99

pDrive Ramp Roller Set



Torque Roller Maintenance Set

G3L

420629224

\$159.99

pDrive Torque Roller Set



XPS TIRES

SHOP BY USAGE



GRAVEL &
HARD PACK



ROCK



MUD

XPS Trail Force



- All-terrain radial tire.
- 8-ply rated construction.
- Versatile and suitable for many types of terrain.
- Aggressive tread pattern for better traction on dirt, mud and rocky terrain.
- Tread depth: 20 mm (0.78").

705402754	•27X9R14	\$134.99
705503103	•27X11R14	\$144.99
705403026	•26X8R14	\$159.99
705503322	•26X10R14	\$179.99

XPS Trail King



- All-terrain radial tire.
- 8-ply rated construction.
- Aggressive tread pattern for tougher terrain.
- An almost continuous center tread offers a smooth other trail ride.
- Tread depth: 26 mm (1.02").

705402825	28X9R14	\$169.99
705403081	27X9R14	\$159.99
705503181	28X11R14	\$174.99
705503355	27X11R14	\$164.99
705402713	26X8R12	\$169.99
705503073	26X10R12	\$174.99

XPS Trac Force



- All-terrain light truck style radial tire.
- 8-ply rated construction.
- Center tread for good grip and comfort on compact terrain.
- Tread depth: 18 mm (0.71").

705403080	30X9R14	\$259.99
705503354	30X10R14	\$269.99
705403416	32X10R16	\$279.99

XPS Hammer Force



- Light truck-inspired tire.
- 8-ply rated construction.
- Rock-crawling tread pattern with unique contact patch.
- Aggressive sidewall for maximum traction when faced with technical terrain.
- Tread depth: 15 mm (0.59").

705402918	30X10R15	\$279.99
-----------	----------	----------

XPS Swamp Force



- Hybrid radial tire for mud and trail.
- 8-ply rated construction.
- Unique tread pattern allowing good grip in mud and mud ejection.
- Center tread provides for comfortable trail riding.
- Tread depth: 36-38 mm (1.41"-1.49").

705403201	30X9R14	\$259.99
705503387	30X11R14	\$279.99

XPS Swamp King



- Bias tires for mud and trail.
- 6-ply rated construction.
- Ultimate performance in mud without sacrificing good trail handling.
- Tread depth: 38 mm (1.49").

705403028	28X8X14	\$189.99
705503324	28X10X14	\$199.99

TIRES & RIMS

Tires

Carlisle ACT Tire	G2 600-1000 XT m odel s onl y)	705401333 •Front	\$164.99
		705401334 •(C€)	\$159.99
		705501769 •Rear	\$179.99
		705501770 •(C€)	\$179.99



- Front-26" x 8" x 12".
- Rear-26" x 10" x 12".

Carlisle ACT Tire	G2 (400 XT m odel s onl y)	705400606 •Front	\$149.99
		705400326 •(C€)	\$149.99
		705500598 •Rear(C€)	\$154.99



- Front-25" x 8" x 12".
- Rear-25" x 11" x 12".

Carlisle ACT HD Tire		705402562 •Front	\$164.99
		705502940 •Rear	\$179.99



- Front-26" x 8" x 12".
- Rear-26" x 10" x 12".

Carlisle Badlands A/ R Tire	G2 600-1000 Base m odel s onl y)	705401331 •Front	\$174.99
		705401332 •(C€)	\$174.99
		705501767 •Rear	\$184.99
		705501768 •(C€)	\$184.99



- Front-26" x 8" x 12".
- Rear-26" x 10" x 12".

Carlisle Trail Wolf Tire	G2 (400 Base m odel s onl y) G2L (450/570)	705402890 •Front	\$144.99
		705400607 •(C€)	\$94.99
		705503225 •Rear	\$149.99
		705502165 •(C€)	\$204.99



- Front-25" x 8" x 12".
- Rear-25" x 11" x 12".

ITP TerraCross Tire	G2 XTP, G2L m ited	705402973 •Front	\$159.99
		705502858 •Rear	\$179.99



- This sm ooth-riding tire will com m and every bit of traction from the ground while still m anaging to float across loose snow, sand and m ud.
- Features extreme-duty construction for im proved puncture protection and extra-tough rubber com pound for increased tread life. The interlocking tread pattern and wide footprint m ake it one of the toughest and grippiest radials around.
- Not EC com pliant.
- Front-26" x 8" x 14".
- Rear-26" x 10" x 14".

ITP Holeshoot ATR Tire	G2S	705400600 •Front	\$184.99
		705400475 •(C)	\$184.99
		705500926 •Rear	\$159.99
		705500820 •(C)	\$159.99



- Front-205/80R12 -25"x8"x12".
- Rear-270/60R12 -25"x10"x12".

ITP Mega Mayhem	G2 X m r570 & 650 2018 & up G2S X m r570 2018 & up	705402131 •Front	\$229.99
		705502645 •Rear	\$234.99



- 1.5" tread depth mud throwertires.
- Surprisingly smooth ride on hard pack surfaces.
- 6-ply rated.
- Front-28"x9"x12".
- Rear-28"x11"x12".

ITP Cryptid Tire	G2 X m r850 & 1000R 2018 & up G2S X m r1000R 2018 & up	705402671	\$309.99
-------------------------	--	-----------	----------



- Graduated lug height and paddle-like shoulder configuration provide maximum side bite for climbing in and out of the mud without compromising ride comfort on trails and hard pack.
- 6-ply rated.
- 30"x9"x14".

Gorilla Silverback Tire	G2 (850 & 1000 models only)	705401501	\$259.99
--------------------------------	-----------------------------	-----------	----------



- AT30X9-14 Gorilla Silverback mud tire.
- Sold individually.
- NotEC compliant.
- 30"x9"x14".

Maxxis Mudzilla Tire	G2 (X m r570 & 650 models only)	705501836 •Rear	\$214.99
-----------------------------	---------------------------------	-----------------	----------



- NotEC compliant.
- Rear-28"x10"x12".

Kenda Klaw MXR Tire	DS 90 X	V42711DGF01HLL •Front	\$104.99
		V42712DGF01HLL •Rear	\$88.99



- Front-20"x6"x10".
- Rear-18"x10.5"x8".

Rims

14" Rim	G2 DPS, G2 XT, G2 MAX 650, G2 MAX XT, G2 MAX Limited	705401853 •Front	■ Black and machined	\$149.99
		705401852 •Front	■ Black with clearcoat	\$144.99
		705401851 •Front	■ Silver with clearcoat	\$139.99
		705502402 •Rear	■ Black and machined	\$159.99
		705502401 •Rear	■ Black with clearcoat	\$149.99
		705502400 •Rear	■ Silver with clearcoat	\$149.99



- Premium cast aluminum black painted with machining and clearcoat rim .
- Center hole: 72 mm .
- Bolt circle pattern: 114 mm .
- Front -14" x 6.5" offset = 40 mm .
- Rear -14" x 8.5" offset = 50 mm .

Note: Matching Nuts - 250100100 Black, 250100082 Chrome/Matching Cap - 705400928

14" Rim	G2 DPS, G2 XT, G2 MAX Limited, G2 North Edition, G2 MAX North Edition	705402309 •Front	■ Black and machined	\$139.99
		705402222 •Front	■ Black with clearcoat	\$164.99
		705402307 •Front	■ Silver with clearcoat	\$139.99
		705502770 •Rear	■ Black and machined	\$159.99
		705502702 •Rear	■ Black with clearcoat	\$164.99
		705502768 •Rear	■ Silver with clearcoat	\$149.99



- Front -14" x 6.5" offset = 40 mm .
- Rear -14" x 8.5" offset = 50 mm .

Outlander X mr and Defender Rim	X m rim odes front and rear wheels	705401848 •Front	■ Black and machined	\$194.99
		705401849 •Front	■ Black	\$204.99



- Cast aluminum rim with trend setting explosive styling so you can ride and look like a trail blazer.
- Front -14" x 6.5" offset = 10 mm .

Note: Matching Nuts - 250100100 Black, 250100082 Chrome/Matching Cap - 705401541

Outlander Rim (Camo Model)	G2, G2L, G2S	705401127 •Front	■ Black with clearcoat	\$159.99
		705501493 •Rear	■ Black with clearcoat	\$179.99



- Black with clearcoat aluminum rim .
- Front -12" x 6" offset = 41 mm .
- Rear -12" x 7.5" offset = 51 mm .

12" Beadlock Rim	G2, G2L, G2S	705401678 •Front	■ Black	\$244.99
		705502244 •Rear	■ Black	\$249.99



- Black with clearcoat aluminum rim .
- Needs 16 bolts (250000787) for installing the beadlock.
- Choice of beadlock color (not included).
- Front -12" x 6" offset = 41 mm .
- Rear -12" x 7.5" offset = 51 mm .

12" Beadlock Ring	G2, G2L, G2S	705401763 • Can-Am Red	\$75.99
		705401810 • Yellow	
		705401811 • Orange Crush	



- Cast aluminum beadlock.
 - Must be installed on Front Rim (705401678) and Rear Rim (705502244).
- Note: Matching Nuts - 250100184 Black, 250100185 Chrome/Matching Cap - 705400928

14" Beadlock Rim	G2	705401594 • Front	■ Black	\$279.99
		705503191 • Rear	■ Black	\$229.99



- Black with clear coat aluminum rim.
- Choice of beadlock color (not included).
- Needs 16 bolts (250000787) for installing the beadlock.
- Front - 14" x 6.5" offset = 41 mm.
- Rear - 14" x 8" offset = 51 mm.

14" Beadlock Ring	G2	705401586 • Manta Green	705401837 • Can-Am Red	\$83.99
		705401702 • Octane Blue	705401840 • Black	



- Cast aluminum beadlock.
 - Must be installed on Front Rim (705401594) and Rear Rim (705503191).
- Note: Matching Nuts - 250100184 Black, 250100185 Chrome/Matching Cap - 705400928*

LUBRICANT & OIL CHANGE KIT

Lubricant

XPS 4T 10 W-50 Synthetic Oil	9779234 • 1 qt / 946 ml	9779235 • 1 US gal / 3.785 L
-------------------------------------	--------------------------------	-------------------------------------



- Engineered for heavy-duty and high-performance 4-stroke engines, including turbocharged, supercharged and racing engines.
- Formulated using carefully selected and strenuously tested base stocks and custom additives.
- Offers thick film strength to protect bearings, and a proven high-temp detergency to minimize deposits, prevents shear, provide them stability, and combat field dilution to ensure maximum performance from your engine.

XPS 4T 0 W-40 Synthetic Oil	9779139 • 1 qt / 946 ml	9779140 • 1 US gal / 3.785 L
------------------------------------	--------------------------------	-------------------------------------



- Powersport formula with premium antiwear and anticorrosion additives.
- The best choice for high-performance snowmobile, ATV and SXS 4-stroke engines used in cold weather.
- Provides superb engine and transmission protection against heat, rust and corrosion.
- Delivers optimal performance in high and low temperatures.

XPS 4T 5 W-40 Synthetic Blend Oil	9779133 • 1 qt / 946 ml	9779134 • 1 US gal / 3.785 L
--	--------------------------------	-------------------------------------



- Off-road formula with premium antiwear and anticorrosion additives.
- Designed for high-performance off-road, on-road and PWC 4-stroke engines, including turbo or supercharged powersports engines.
- Provides superb engine and transmission protection against rust and corrosion, even in extreme conditions.

Oil Change Kit

Engine Oil Change Kit



- Ultra-convenient all-in-one Engine Oil Change Kit saves time and money.
- Includes XPS Synthetic or Synthetic Blend Oil, oil filter, O-rings and washer.

Models

5W-40 Synthetic Blend Oil/ 450 cc or less	9779256
0W-40 Synthetic Oil/ 450 cc or less	9779257
5W-40 Synthetic Blend Oil/ 500 cc or more V-twin engine	9779258
0W-40 Synthetic Oil/ 500 cc or more V-twin engine	9779259
10W-50 Synthetic Oil/ 500 cc or more V-twin engine	9779252
0W-40 Synthetic Oil/ 650 ACE	9779481
5W-40 Synthetic Blend Oil/ 900 ACE	9779260
10W-50 Synthetic Oil/ 900 ACE	9779261

MAINTENANCE PRODUCTS

Synthetic Gear Oil

75W-90
75W-140

9779158 • 1 qt / 946 ml
9779160 • 1 qt / 946 ml



- Uses custom additives to provide the best performance in Visco-Lok™ and Smart-Lok™ differentials.
- Allows higher loads, superior shear stability and reduced oxidation.
- Exceptional wear protection and superior performance at all operating temperatures.

Extended Life Pre-Mixed Coolant

9779150 • 1 qt / 946 ml



- Antifreeze/coolant contains the correct dilution and the necessary additives to prevent corrosion and inhibit cavitation in BRP cooling systems.
- Long-life, 5-year formula specially formulated for BRP vehicles.
- Superior heat transfer.
- Ideal replacement for vehicles that normally use a 2-year antifreeze/coolant (green).
- 5 years (orange).

Anti-Corrosive Lubricant

9779166 • US 12 oz / 340 g
9779167 • CDN 12 oz / 340 g



- Multipurpose lubricant that can also be used to prevent rust, corrosion and moisture intrusion.
- It contains extreme pressure additives that work as an all-around lubricant for just about any where lubrication is needed.

Extreme Duty Suspension Grease

(Not Illustrated)

9779708 • 14 oz / 400 g

- Designed to work specifically with the components found in Can-Am vehicle suspensions.
- It is highly stable and offers optimal lubrication at both extreme cold and high temperatures while protecting suspension components from dirt and moisture, as well as corrosion under extreme washout conditions.

XPS Spline Grease

(Not Illustrated)

9779704 • 4 fl oz / 118 ml

- Enhanced rust and corrosion resistance.
- Protects against seizure, heat freeze, galling, rust and corrosion.

DOT 4 Brake Fluid

9779151 • 12 fl oz / 355 ml



- Meets or exceeds all DOT 3 and DOT 4 brake fluid requirements.
- High-temperature formula resists fade and also conditions seals and O-rings in braking system.

Racing Brake Fluid RS600

9779152 • 12 fl oz / 355 ml



- Exceeds DOT 4 brake fluid requirements for extreme conditions and competition use.
- Extreme, 579-degree boiling point temperature is ideal for high-demand and competition conditions to combat brake fade.
- Will not harm seals or braking system components.
- Should be added only to a clean/unfilled system to avoid dilution and diminished performance.
- Low-moisture formula slows water vapor absorption through multiple heat cycles.
- Recommended for use in Ski-Doo and Can-Am racing applications.

Fuel Stabilizer

9779171 • 8 fl oz / 236 ml



- Ethanol compatible and will stabilize fuel in your tank to keep it from breaking down and causing hard starting, throttle hesitation and poor run quality.
- Since ethanol attracts moisture, this product contains powerful anti-corrosion additives to protect fuel system components.
- Prevents problems associated with E10 fuels.

CARE PRODUCTS

Cleaner and Degreaser, All Purpose

9779328 • 22 fl oz / 650 ml

9779329 • 2 qt / 1.89 L



- Ready-to-use formula.
- Cleans toughest dirt and grime.
- Phosphate free eco-friendly formula.
- Low-foam easy rinse formula.

Matte Finish Waterless Cleaner

9779330 • 22 fl oz / 650 ml



- Easy waterless use.
- Perfect for matte, flat and denim surfaces.
- Contains no wax or silicone.
- Leaves no unwanted streaks or marks.

Multi-Surface and Glass Cleaner

9779331 • 22 fl oz / 650 ml



- Easy waterless spray and wipe use.
- Polymer formula cleans and protects.
- Contains no wax or silicone.
- Leaves no unwanted streaks or marks.

Mud and Dust Off -Road Wash

9779340 •33 fl oz / 946 m l

9779341 •2 qt / 1.89 L



- Specially formulated for off-road vehicles, it breaks the bond holding grime and dirt to your vehicle's finish.
- The formula is biodegradable, eco-friendly with no phosphates or corrosive chemicals and is low foam, foamy, quick rinsing.
- Effective on oil, grease and other stubborn grime.
- Safe for use on all surfaces.

Black Plastic and Rubber Restorer

9779335 •7.6 fl oz / 225 m l



- Restores plastic, rubber and vinyl.
- Long-lasting formula.
- Protects against UV rays.

Foaming Wash

9779337 •16 fl oz / 473 m l

9779338 •2 qt / 1.89 L



- Concentrated formula for off-road vehicles, it produces a thick foam to lift dirt and prevent scratching.
- The pH neutral formula is safe for wax and paint sealants.
- Works in pressure washers or by hand.

Quick Detailer Gloss Enhancing

9779332 •4 fl oz / 118 m l

9779333 •16 fl oz / 473 m l



- Quick detail spray wax.
- Leaves a high gloss finish at every wipe.
- Nanotechnology polymer formula.
- Repels dirt.
- No water needed.



BRP REIMAGINES THE WAY YOU ACCESS YOUR WORLD

Can-Am is one of many success stories from BRP, the global company behind some of the most daringly innovative products and experiences that move you. Because it's not about the destination, it's about the journey — yours.

Discover our brands:

ski-doo ***LYNX*** ***SEA-DOO*** ***can-am*** ***ROTAX*** ***ALUMACraft*** ***MANITOU*** ***QUINTREX***

www.brp.com





CANAMOTROAD.COM

M Y24 716001904

A BRP BRAND

